

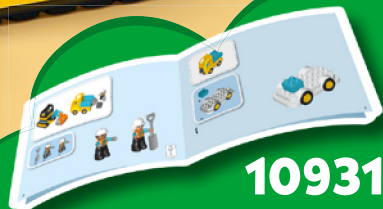

  
**duplo**



**10931**

LEGO.com/DUPL0

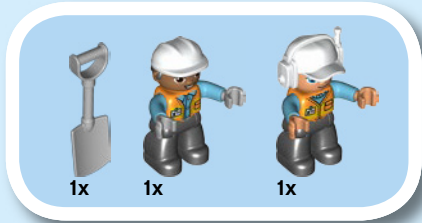

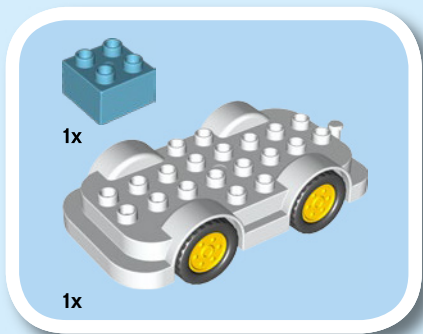

1

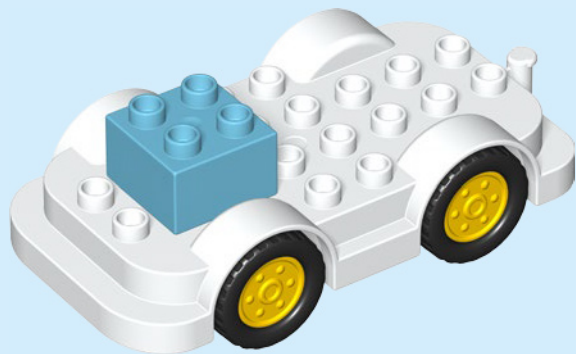

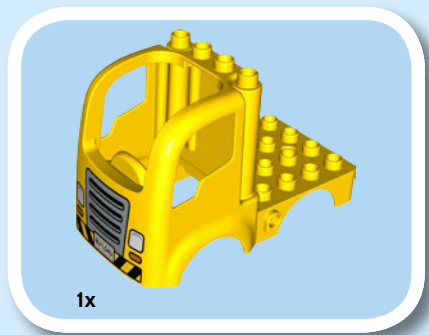

2



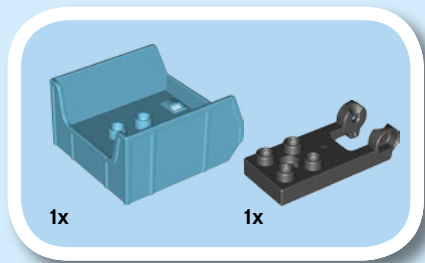

**3**

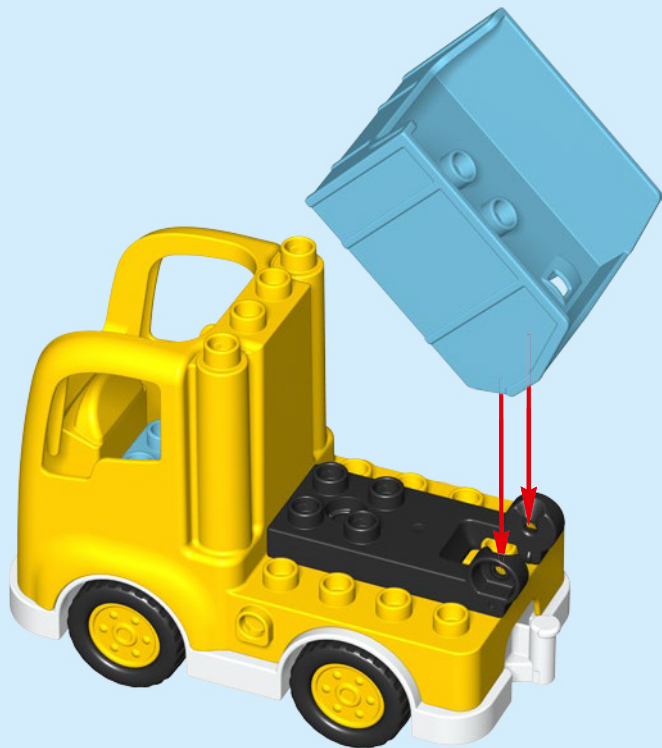

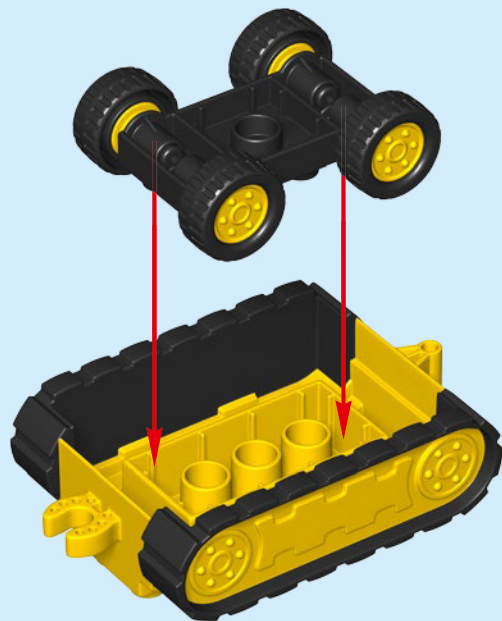
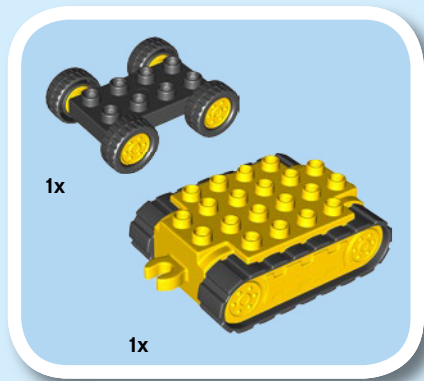

1

6

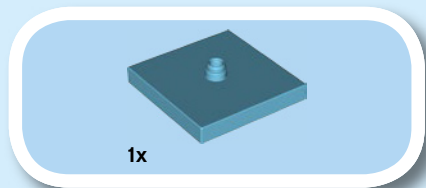

2

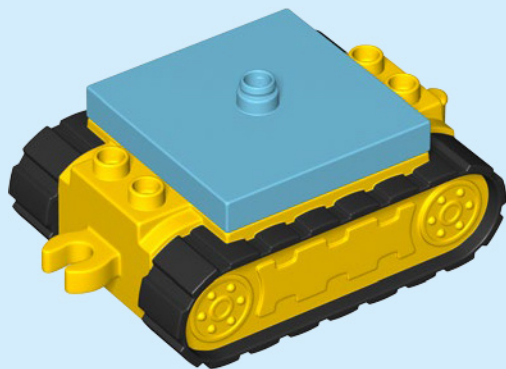



3

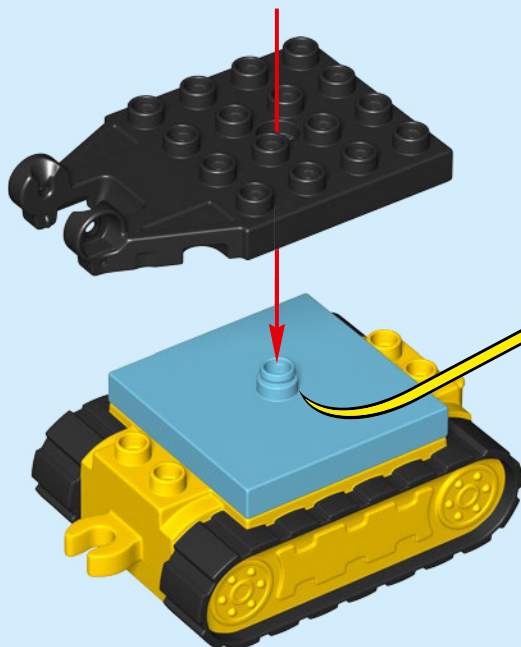



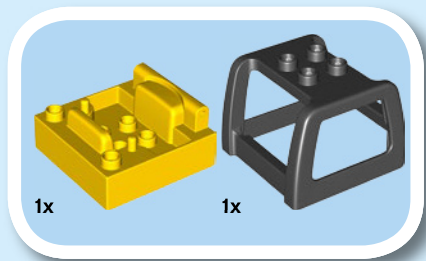

4

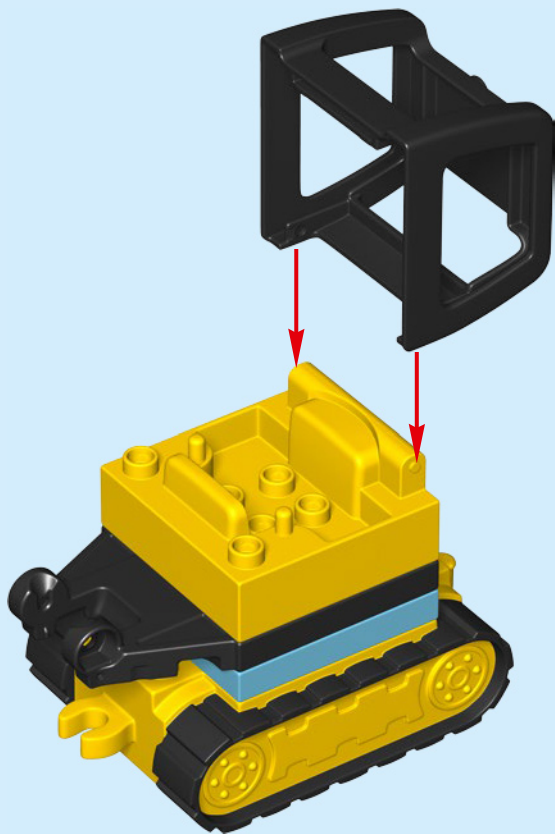

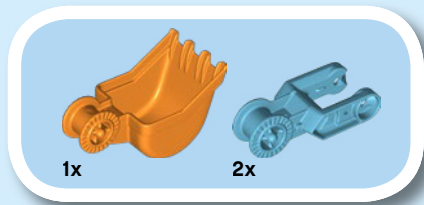

5

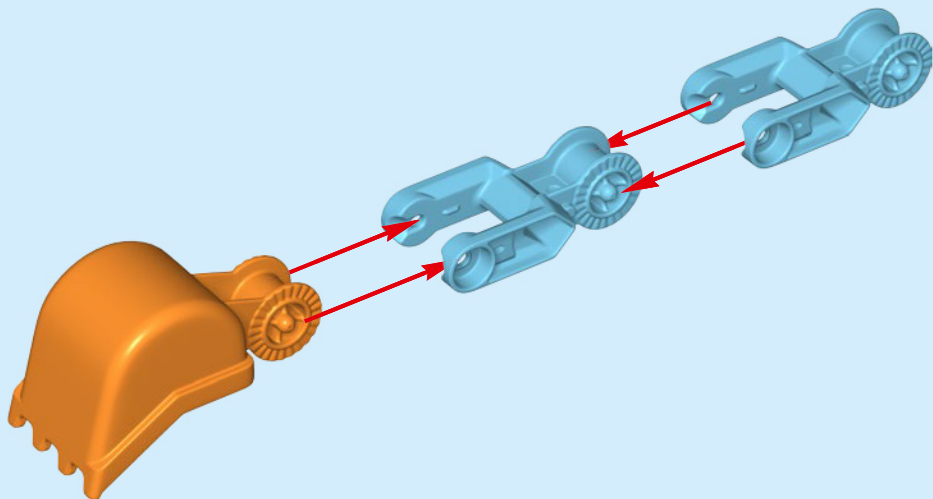

6

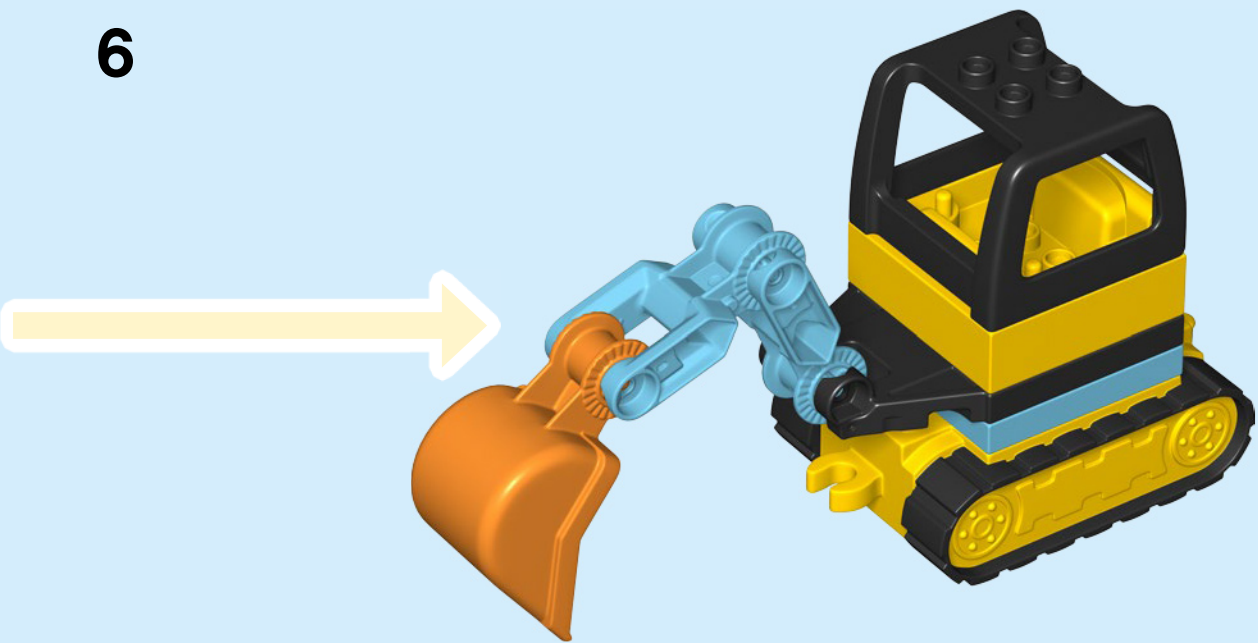



7

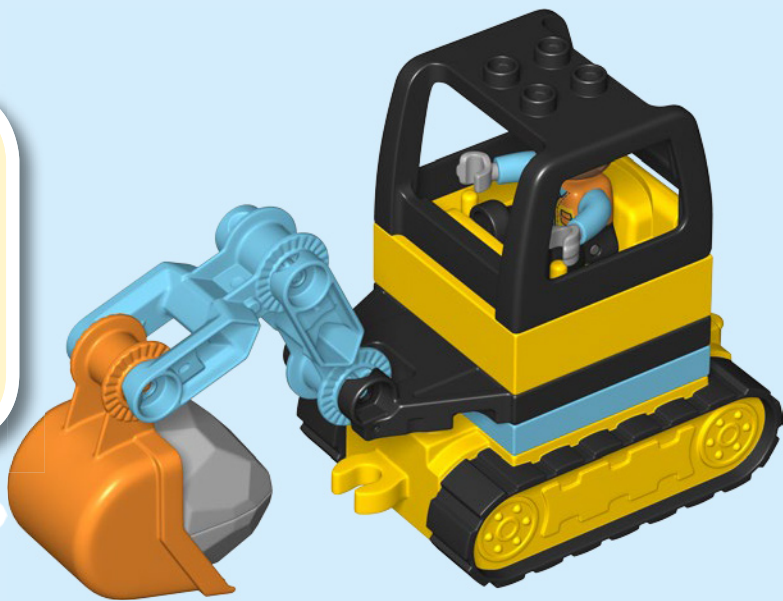
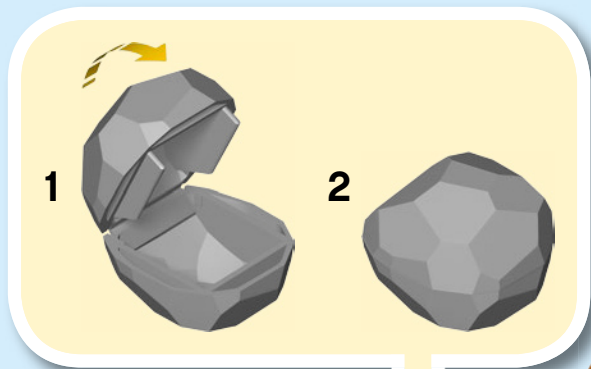

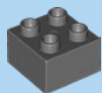

1x

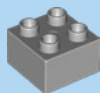

1x

8

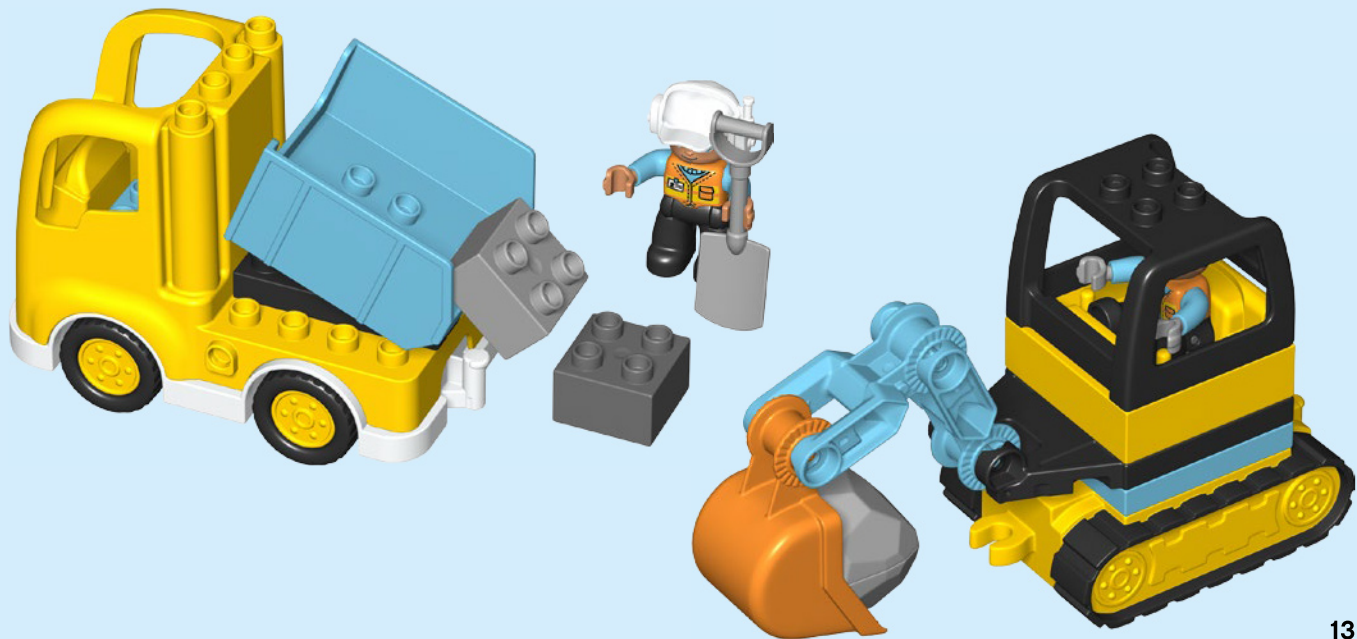



# duplo

Age

# 1 1/2

10915  
Age 1 1/2+



Light brick  
Leuchtbaustein  
Brique lumineuse  
Mattoncino luminoso  
Ladrillo luminoso  
Peca luminosa  
Világító elem  
Gaismas klucitís  
发光积木

LIGHT BRICK

# 2+

10933  
Age 2+



LIGHT & SOUND

LIGHT & SOUND

PUSH & GO

Push & Go  
Actionné par poussée  
Told és indul  
Inercos motors  
一推就走

Light & sound  
Licht und Ton  
Effets sonores et lumineux  
Luci e suoni  
Luz y sonido  
Luz e som  
Fény és hang  
Gaismas un skapas  
声效与光效

10913  
Age 1 1/2+

Extra Ideas Included  
Mit zusätzlichen Bauidéen  
Idées supplémentaires incluses  
Idee aggiuntive incluse  
Incluye ideas extra  
Inclui Ideias Extra  
Extra ötletek a csomagban  
leklautas papildu idejas  
内含更多创意

EXTRA  
IDEAS  
INCLUDED



65 pieces  
1 1/2+





# A WORLD OF LEGO® DUPLO®

EINE LEGO® DUPLO® WELT / LE MONDE DE LEGO®  
DUPLO® / UN MONDO DI LEGO® DUPLO® / UN MUNDO  
DE LEGO® DUPLO® / UM MUNDO DE LEGO® DUPLO® /  
A LEGO® DUPLO® VILÁGA / LEGO® DUPLO® PASAULE  
丰富多彩的乐高®得宝®世界

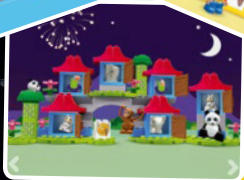

The availability of apps is subject to the local strategies of the LEGO Group.

Die Verfügbarkeit der Apps unterliegt der Strategie der LEGO Gruppe für das jeweilige Land.

La disponibilité des applications est soumise aux stratégies locales du groupe LEGO.

La disponibilità dell'app è soggetta alle strategie locali del LEGO Group.

La disponibilidad de las apps está sujeta a las estrategias regionales de The LEGO Group.

A disponibilidade das apps está sujeita às estratégias locais do Grupo LEGO.

Az alkalmazások elérhetőségét a LEGO Csoport helyi stratégiája határozza meg.

Lietotņu pieejamība ir atkarīga no LEGO Group vietējās stratēģijas.

相关应用是否在当地发行取决于乐高集团在当地的市场策略



Customer Service

Kundenservice

Service Consommateurs

Servicio Al Consumidor

LEGO.com/service or dial

 : 00800 5346 5555

 : 1-800-422-5346



Terms & Conditions apply

Go to [www.LEGO.com/productfeedback](http://www.LEGO.com/productfeedback)  
and give us your short  
**win**  
**feedback** about this  
LEGO® DUPLO® set for a chance to win  
a cool LEGO prize

## LEGO.com/productfeedback

### GEWINNE

Erzähle uns auf  
[www.LEGO.com/productfeedback](http://www.LEGO.com/productfeedback)

etwas über die Erfahrungen, die du  
mit diesem LEGO® Set gemacht hast,  
und sichere dir die Chance auf einen  
coolen LEGO Preis!

Es gelten die Teilnahmebedingungen

### GAGNE

Rends-toi sur  
[www.LEGO.com/productfeedback](http://www.LEGO.com/productfeedback)

et donne-nous quelques commen-  
taires sur ce produit LEGO® pour  
avoir une chance de gagner un  
prix LEGO !

Voir Conditions Générales

### GANAN

Visita  
[www.LEGO.com/productfeedback](http://www.LEGO.com/productfeedback)

y envíanos tu opinión acerca de este  
set LEGO®. ¡Participarás en el sorteo  
de un premio LEGO!

Términos y Condiciones aplicables

### 获取奖品

登录  
[www.LEGO.com/productfeedback](http://www.LEGO.com/productfeedback)

给出关于此乐高®套装的简短反  
馈，就有机会获得炫酷乐高奖品

《条款及条件》适用

LEGO, the LEGO logo and DUPLO are trademarks of the LEGO Group. ©2020 The LEGO Group.