



# X800C Speedlite

For Ca



English

Instruction Manual

## Warning

- Do not expose this product in high temperature location or confined spaces exposed to strong direct sunlight and other overheating places.
- Keep it dry. Do not touch this product with wet hand. Do not expose this product to water or rain, or you may not be able to use it.
- Do not use it in inflammable gas, or it may cause explosion or fire.
- This product involved in battery. Please strictly follow the corresponding operations related to battery, or it may cause explosion or fire.
- Do not put the component in strong vibration, or it may cause fault of this product.
- Remove the batteries during long periods of non-use.
- Do not use the flash light in a short distance from the eyes, or it may cause possible injury to eyes or blindness.
- After continuous use, it will be very hot. Do not touch, or it may cause burn.
- After continuous use, the battery might be hot. Please be careful when changing new battery.
- Do not disassemble or maintain this product by yourself. The internal high voltage will cause electric shock.
- Only the same brand and battery type can be used.

## Specifications

<b>GN:</b>	60 (ISO100 200mm)
<b>Flash Coverage Range:</b>	20 -200mm
<b>Auto Zoom:</b>	According to shooting angle and image to auto adjust the coverage range
<b>Manual Zoom:</b>	According to camera or flash setting to adjust the zoom range
<b>Flash Mode:</b>	ETTL/M/Mult
<b>Stroboscopic Flash:</b>	1-500Hz
<b>Wireless Flash:</b>	Radio transmission/ Optical transmission support optical control/ Slave, S1/S2
<b>SYNC Mode:</b>	High Speed Sync, 1st Curtain Sync, 2nd Curtain Sync
<b>Adjustable Angle:</b>	Up/down: -7/90 degree Left / Right: 180 degree/180 degree
<b>Manual Flash:</b>	1/128-1/1 output control (1/3rd increments)
<b>Recycle Time:</b>	Less than 2.5 sec (1/1 full power output)
<b>LCD Display Screen:</b>	High definition dot matrix screen
<b>Internal Power Source:</b>	4×AA size alkaline batteries or rechargeable batteries (4×1.5V)
<b>External Interface:</b>	Hot shoe, PC port, USB port, external power port
<b>EV:</b>	In 1/3rd increments (±3 stops)
<b>FEB:</b>	In 1/3rd increments (±3 stops)
<b>Battery Life:</b>	180 times (1/1 flash output, with Sanyo Eneloop batteries)
<b>Fluorescent tube:</b>	Ultra-long battery life design
<b>Overheating Warning:</b>	Multi dot matrix temperature control, battery overheating warning
<b>AF-Assist Beam:</b>	Support
<b>Firmware Upgrade:</b>	Support
<b>Dimension:</b>	78.04mm×60.50mm×193.00mm
<b>Weight:</b>	408.7g (excluding batteries)

# Component Name

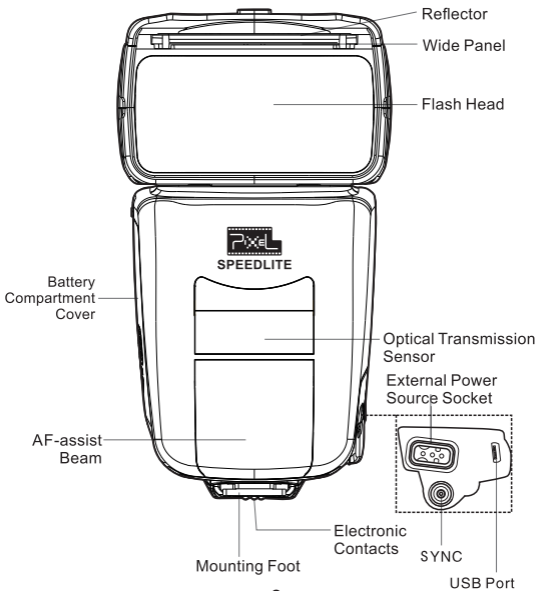
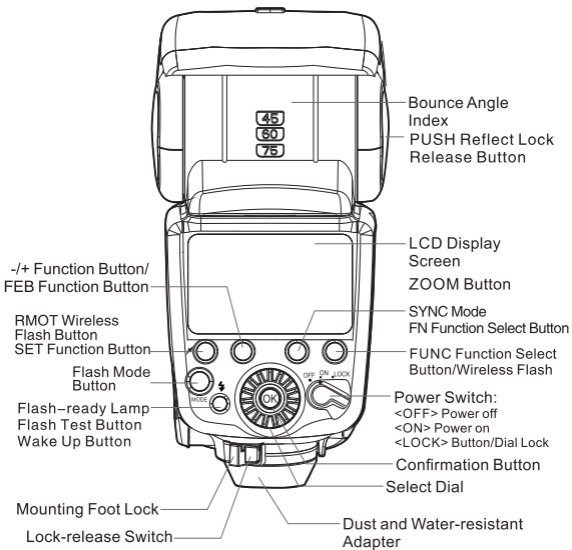

# Operation Interface

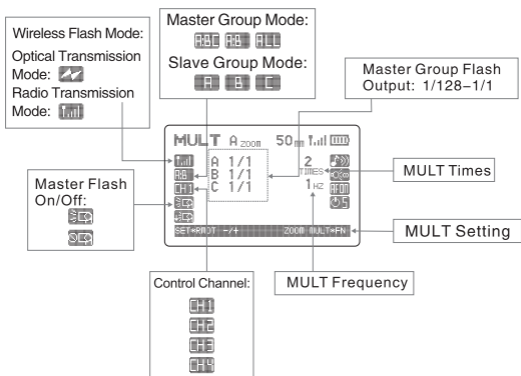
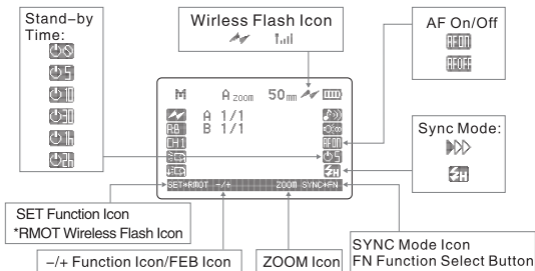
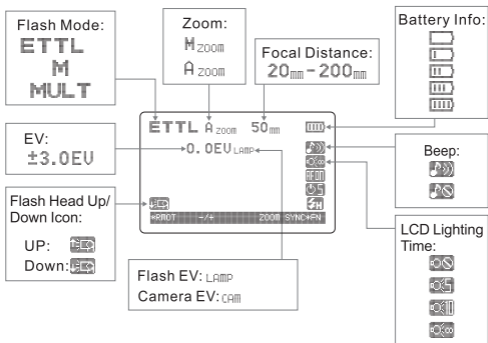

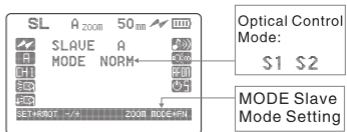
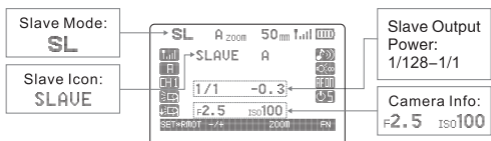
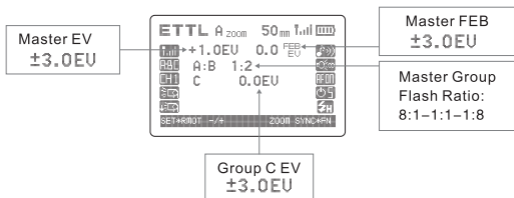

## Introduction

Thanks for using Pixel X800C speedlite. X800C is a new generation speedlite which is elaborately design by Pixel. With the continuation and surpass on the previous generation speedlite featuring high performance, it also provide you smaller size which will make your shooting more relaxing. The scientific design and selected high-end imported original component make X800C's performance more extraordinary. With energy-saving design, its lifetime and working hours will be extended tremendously. And the recycle time is less than 2.5 sec in full power output which is improved by 20% compared to that of previous generation. Faster and more reliable; the battery life up to 180 times in full power output; the GN is powerful as well, up to GN60 (ISO100, focal distance200mm). Moreover, it added Pixel wireless control system FSK 2.4GHz which is compatible with King PRO and King wireless control; Also, user can upgrade the firmware via mini USB interface, allowing you enjoy a thoughtful upgrade service provided by Pixel. Pixel X800C speedlite is an indispensable good helper for your shooting.

### Dial Selector

This dial selector is applied to adjust setting parameter of the flash. Turn left to reduce setting parameter, and turn right to increase setting parameter.

### **\*RMOT Wireless Flash Button**

Press and hold this button to enter wireless control mode. The wireless mode and optical transmission mode can be set individually. First, press and hold this button to enter wireless flash mode; and then press and hold this button again to enter Slave mode; and press and hold once again to exit wireless flash mode.

SET\*RMOT: namely gently press to set SET function. Press and hold this button to enter next function. With\*mark function button means press and hold this button to enter the corresponding function setting.

### **-/+ Function Button**

This function button is applied to adjust output parameter of the flash, FEB and other functions. Function adjustment alters from shooting mode. It's subject to image display function. FEB, namely flash exposure bracket. When displaying FEB, you may set flash exposure bracket.



### **ZOOM**

This Zoom button is applied to set Zoom mode. Zoom mode includes manual zoom [M<sub>zoom</sub>] and auto zoom [A<sub>zoom</sub>]. Set this function with dial selector.



※ Focal distance can set as 20-200mm. Some cameras do not support higher focal distance. The setting of focal distance is subject to camera. In a range of 20-200mm, it will be displayed correctly. But an error may occur if out of this range.

### **SYNC\*FN**

SYNC\*FN button can set flash sync mode and FN function settings individually.





SYNC\*FN: gently press this button to set flash sync mode. Press and hold this button to enter FN function setting. SYNC can set HSS, 1st curtain sync and 2nd curtain sync mode. Gently press this button to set HSS [  ], 1st curtain sync [ it won't show the icon ], 2nd curtain sync [  ]. Please select the sync mode as needed. Press and hold this button to enter Beep Setting, LCD Lighting Time Setting, AF-assist Beam Setting and Stand-by Time Setting.

#### **Beep Setting**

Press and hold to enter FN function setting, and then turn dial selector to turn on beep [  ] or turn off beep [  ], then press OK to confirm the settings.

#### **LCD Lighting Time Setting**



Press and hold to enter FN function setting, and then continuously press this button to move the setting icon to LCD Lighting Time Setting, and then turn dial selector to select LCD Lighting Time:

[  ] means on all the time,  
[  ] means on for 5 sec,  
[  ] means on for 10 sec,  
[  ] means turn off the light,  
Press OK to confirm the settings.

#### **AF-assist Beam Setting**

AF-assist beam is mainly applied to low-light or low contrast shooting environment. Under this condition, the

built-in AF-assist beam activates automatically to help autofocus.

Press and hold to enter FN function setting, and then continuously press this button to move the setting icon to AF-assist Beam Setting, and then turn dial selector to turn on AF [  ] or turn off AF [  ]. Press OK to confirm the settings.

### Stand-by Time Setting

Press and hold to enter FN function setting, and then continuously press this button to move the setting icon to Stand-by Time Setting, and then turn dial selector to select stand-by time:

[  ] means 5mins stand-by time,

[  ] means 10mins stand-by time,

[  ] means 30mins stand-by time,

[  ] means 1hr stand-by time,

[  ] means 2hrs stand-by time,

[  ] means non-sleep mode.

Press OK to confirm the settings. When under wireless Slave mode, the default stand-by time as 1 hour.

When flash entered sleep mode, the flash display screen will show [  ] icon. Half-press camera shutter or Flash Test Button to wake up the flash.

### LOCK

It's applied to lock the parameter settings of the flash, avoiding the flash parameter may be changed accidentally.

### MODE

Flash mode button. It's applied to set the flash mode. You can set the flash mode to E TTL full auto flash, Manual flash and Mult flash mode individually. Press and hold this button to reset your flash to the original factory settings.

### E TTL

E TTL Flash Mode. The camera and flash metering system will work together to make correct exposure, thus the shooting subject and background will get balanced exposure. Under this mode, it's available to set the EV and FEB. The EV and FEB adjustable power is between -3.0EV to + 3.0EV in 1/3 increments.

### M

Manual Flash Mode. You can set the flash output from 1/128 power to 1/1 full output in 1/3 increments. Set flash output power with dial selector. Turn left to reduce setting parameter, and turn right to increase setting parameter.

### MULT

Mult Flash Mode. Mult flash mode can make one image displays as a serial continuous moving image. Under Mult flash mode, you can set flash output power, flash times and flash frequency.

- ✘ Mult frequency can set as 1-500 Hz. Frequency setting is subject to camera. Some cameras do not support higher frequency.
- ✘ To avoid the damage of flash head due to overheating, do not use Mult flash shooting over 10 times. After 10

continuous flashes, allow a rest time of the flash at least 15mins.

- ※ If you fire more than 10 continuous flashes, the safety function may activate and restrict flash firing. If this happens, please allow a rest time of the flash at least 15mins.

### USB Port

It's applied to upgrade the firmware. You can download the newest firmware from Pixel website.

Website: [www.pixelhk.com](http://www.pixelhk.com)

### PC Port

It's applied to connect camera with SYNC cable or trigger flash.

### PUSH Reflect Lock Release Button

By pressing this button, the flash head can be adjusted to up/down and left/right. Up/down ward angle -7 to 90 degree, left/right angle 180 degree.

### Reflector

Using the reflector enables you to reflect light in a person's eyes and create a more vivid expression.

When using, pull out the reflector and wide panel together, and push back the wide panel. Then you may use the reflector.

### Wide Panel

Using wide panel, flash coverage range will enlarge.

When using, pull out the reflector with wide panel together, and push back reflector. Then you may use the wide panel.

## Support Camera External Flash Menu Control

X800C speedlite can control flash mode, output power, exposure compensation, FEB, focus, sync mode and other functions via camera flash settings menu. (Only for cameras equipped with flash setting menu)

- ※ While controlling exposure compensation on X800C speedlite via camera flash setting menu, the exposure compensation value should set as 0 EV, or you may not be able to set camera exposure compensation. When flash LCD screen shows CAM, it means camera output exposure compensation. When flash LCD screen shows LAMP, it means flash output exposure compensation.
- ※ When controlling wireless flash on the speedlite via camera flash setting menu, you can only control wireless flash on the speedlite from camera menu by selecting optical transmission. The flash wireless flash control and optical transmission control can only be set on the speedlite. The wireless flash control of X800C is not compatible with that of Canon original speedlite. It's not available to select radio transmission from camera menu.

## Wireless Flash Control

X800C is equipped with optical transmission flash control and radio transmission flash control function.

[  ] Optical transmission mode;

[  ] Radio transmission mode.



## Optical Transmission Control

X800C speedlite supports optical transmission flash control function. The speedlite mounted on the camera can transmit signal via optical pulse to control firing remotely. When using wireless flash mode, the speedlite mounted on the camera should set as Master mode, and the off-camera flash set as Slave mode. Optical transmission flash is achieved by optical pulse, not wireless signal transmission, so the transmission distance is very short. Please note the following issues when using:

1. Make sure the slave unit within effective control range when using optical transmission flash mode;
2. The receiving signal sensor of slave unit should face to master unit;
3. You are required to use flashes that are equipped with an optical transmission wireless shooting function;
4. Please do not place any obstacles between the master unit and slave unit when using optical transmission flash mode, or it may affect optical signal transmission;
5. Under optical transmission flash mode, use ETTL flash and M flash support high speed sync (HSS) and 1st curtain sync. When using MULT flash, it supports 1st curtain sync.

### Optical Transmission Flash Function Parameter

Transmission Method: Optical pulse

Mode Control: Master/Slave

Channel Control: 1-4 channels

Group Control: 3 groups (A/B/C)

Transmission Distance: about 0.7-10m

Horizontal:  $\pm 40^\circ$ ; Vertical:  $\pm 30^\circ$  (facing to master unit)

Flash Ratio Control: 1:8-1:1-8:1

Sync Mode: HSS, 1st curtain sync

### Optical Transmission Flash Control Operation Introduction

Press and hold \*RMOT button to enter wireless flash master mode; after entered wireless flash mode, press and hold SET RMOT button to enter wireless flash Slave mode. Press and hold again to exit wireless flash mode.

Optical Transmission mode can set Master/Slave group control, channel control, Master flash On/Off.

#### 1. Master/Slave Mode Setting

Master Mode Setting: press and hold \*RMOT button to enter wireless flash control mode. Gently press this button again and then turn dial selector to select optical transmission mode [  ]. If this mode is already displayed after entered wireless flash control interface, then there is no need to make setting. When using optical transmission flash, the speedlite mounted on the camera should set as this mode.

Slave Mode Setting: after entered wireless flash mode, press and hold SET\*RMOT to enter Slave mode [SL]. Gently press SET\*RMOT button again and then turn dial selector to select Slave optical transmission mode [  ]. If this mode is already displayed on the interface after entered slave mode, then there is no need to make setting.

## 2. Group Control Setting

After entered wireless flash Master mode, continuous press SET\*RMOT button, and then move setting icon to Group Control Setting [ALL], then turn dial selector to select the group as needed.

Master Group Mode Switch: ALL→A→:B→A:BC



Slave Group Mode Switch: A→B→C

## 3. Flash Channel Setting

After entered wireless flash Master mode, continuous press SET\*RMOT button, and then move setting icon to Channel Setting [CH1], then turn dial selector to select flash channel. Optional channel: CH1-CH4, 4 channels in total. Slave flash channel need to set in the slave interface, the method is the same as master channel setting.

If the transmission channels of the master unit and slave unit are different, then the slave unit won't fire. Both Master and slave must be set to the same channel.

## 4. Master Flash On/Off Setting

After entered wireless flash Master mode, continuous press SET\*RMOT button, and then move setting icon to Master Flash On/Off [  ], then turn dial selector to select Master Flash On [  ] or Off [  ].

When flash is On, master flash will join in exposure.

When flash is Off, master flash will not join in exposure.

※ Under Slave mode, it's not available to set flash On/Off. Here flash is On by default.

## ETTL Mode

Under ETTTL mode, you can set group flash ratio, ALL→A:B→A:BC.

1. A:B can set the flash ratio of group A ,B;
2. A:BC can set the flash ratio of group A, B. Under this mode, group C is independent which can be set individually;
3. Under ALL mode, all of units will join in firing.

※ If need more flash output, you can invite the numbers of the slave unit which is unlimited.

## M Mode

Under manual wireless flash mode, the Master unit can set different flash output for every slave flash (every group).

1. A:B can set the flash output of group A ,B, except group C;
2. A:BC can set the flash output of group A, B, C. Each group unit is independent, without interference.
3. Under ALL mode, all of units will join in firing.

## MULT Mode

1. A:B can set different flash output of group A and B individually, except group C. The frequency and flash times of group A and B are the same;
2. A:BC can set the flash output of group A, B, C. The flash power of the three groups can be set separately. And the frequency and flash times of the three groups are the same;

3. Under ALL mode, all of units will join in firing. The frequency and flash times of every firing group are the same.

- ※ Under MULT mode of optical transmission flash, flash frequency can be set between 1-199Hz.
- ※ Optical transmission is achieved by optical pulse, so its transmission performance is not so good and transmission distance is short. For better use wireless flash function, we are advised to use wireless flash mode. Being less affected by obstacles, wireless signal transmission and control efficiency are much higher.

### **S1/S2 Optical Control Mode**

**S1 Manual Optical Transmission Mode:** when set flash as this mode, it can work with the first firing of the Master flash synchronously. Set Master flash as manual M mode. The E TTL or MULT mode cannot be fired.

**S2 E TTL Optical Transmission Mode:** when set flash as this mode, it can fire with the E TTL mode of the Master flash synchronously. Set Master flash as E TTL auto metering mode. The M or MULT mode cannot be fired.

1. After entered Slave Mode (SL), gently press MODE\*FN button and then turn dial selector to select MODE S1 or MODE S2 mode.
2. Under Slave MODE S1 or MODE S2 mode, press +/- and then turn dial selector to adjust the output power of Slave Flash.

- ※ MODE\*FN: namely gently press Slave mode, press and hold to enter FN function setting.

## **Wireless Flash Control**

X800C speedlite is equipped with radio transmission flash function. With radio transmission, flash firing is less affected by obstacles, so its transmission and control efficiency are much higher. When using with Pixel King PRO and OPAS flash trigger, or among X800C speedlites (Master/Slave), you can use wireless transmission flash.

### **Radio Transmission Flash Function Parameter**

Transmission Method: FSK2.4GHz  
Mode Control: Master/Slave  
Channel Control: 1-4 channels  
Group Control: 3 groups (A/B/C)  
Transmission Distance: about 50M  
Flash Ratio Control: 1:8-8:1  
Sync Mode: HSS, 1st curtain sync

### **Wireless Flash Control Operation Introduction**

Wireless flash control can set Master/Slave group control, channel control, Master flash On/Off.

#### **1. Master/Slave Mode Setting**

Master Mode Setting: press and hold \*RMOT button to enter wireless flash control mode. Gently press this button again and then turn dial selector to select radio

transmission mode[]. If this mode is already displayed after entered wireless flash control interface, then there is no need to make setting. When using wireless flash, the speedlite mounted on the camera set as this mode.

Slave Mode Setting: after entered wireless flash mode, press and hold SET\*RMOT button to enter Slave mode [SL]. Gently press this button again and then turn dial selector to select Slave optical transmission mode[]. If this mode is already displayed on the interface after entered slave mode, then there is no need to make setting.

## 2. Group Control Setting

After entered wireless flash Master mode, continuous press SET\*RMOT button, move setting icon to Group Control Setting [ALL], then turn dial selector to select the group as needed.



Master Group Mode Switch: ALL→A:B→A:BC

Slave Group Mode Switch: A→B→C

## 3. Flash Channel Setting

After entered wireless flash Master mode, continuous press SET\*RMOT button, and then move setting icon to Channel Setting [CH1], then turn dial selector to select channel. Optional channel: CH1-CH4, 4 channels in total. Slave flash channel need to set in the slave interface, the method is the same as master channel setting. If the transmission channels of the master unit and slave unit are different, then the slave unit won't fire. Both Master and slave must be set to the same channel.

## 4. Master Flash On/Off Setting

After entered wireless flash Master mode, continuous press SET\*RMOT button, and then move setting icon to Master Flash On/Off[], then turn dial selector to select Master Flash On [] or Off [].

When flash is On, master flash will join in exposure.

When flash is Off, master flash will not join in exposure.

※ Under Slave mode, it's not available to set flash On/Off. Here the flash is On by default.

## ETTL Mode

Under ETTL mode, you can set group flash ratio, ALL→A:B→A:BC.

1. A:B can set the flash ratio of group A ,B;
2. A:BC can set the flash ratio of group A, B. Under this mode, group C is independent which can be set individually;
3. Under ALL mode, all of units will join in firing.

※ If need more flash output, you can invite the numbers of the slave unit which is unlimited.

## M Mode

Under manual wireless flash mode, the Master unit can set different flash output for every slave flash (every group).

1. A:B can set the flash output of group A ,B, except group C;
2. A:BC can set the flash output of group A, B, C. Each group

unit is independent, without interference;

3. Under ALL mode, all of units will join in firing.

### **MULT Mode**

1. A:B can set different flash output of group A and B individually, except group C. The frequency and flash times of group A and B are the same;
2. A:BC can set the flash output of group A, B, C. The flash power of the three groups can be set separately. And the frequency and flash times of the three groups are the same;
3. Under ALL mode, all of units will join in firing. The frequency and flash times of every firing group are the same.

- ※ Under MULT mode of optical transmission flash, flash frequency can be set between 1-199Hz.
- ※ Optical transmission is achieved by optical pulse, so its transmission performance is not so good and transmission distance is short. For better use wireless flash function, we are advised to use wireless flash mode. Being less affected by obstacles, wireless signal transmission and control efficiency are much higher.

### **Error Warning Prompt**

When an error occurs on the flash or overheating protection is activated, the following information will display on the screen:

Motor Error Prompt:

WARNING: MOTOR ERROR

Motor Error, Battery and Flash Head Overheating

Prompt:

WARNING: MOTOR ERROR BAT LAMP TEMPERATURE

Motor Error, Flash Head Overheating Prompt:

WARNING: MOTOR ERROR LAMP TEMPERATURE

Flash Head Overheating Prompt:

WARNING: LAMP TEMPERATURE

Battery Overheating Prompt:

WARNING: BATTER TEMPERATURE

Unknown Error Prompt:

WARNING: ERROR 90

- ※ When a prompt occurs on flash motor and unknown error, you are advised to switch on-off the flash repeatedly to make it self-recovery. After recovery, the prompt info will disappear, and you can reuse it. If not, you are advised to contact the dealer for repair.
- ※ When you use the flash continually, flash head and battery overheating protection will be activated, then the LCD display screen will shows error prompt and restrict flash firing. Now please turn off the flash and allow a rest time for reuse. Then the prompt info will disappear, and you can reuse it.

### **Warranty**

One year warranty from the day of purchase. Please kindly contact Pixel or distributor for more details.

Thank you for using Pixel product and read this instruction manual. If you have any questions, please contact your local dealer or visit <http://www.pixelhk.com>

The instruction manual is dated January 13, 2015. For information on the compatibility with accessories marketed after this date, please contact Pixel's dealer for advice.

