

Data Projector

Operating Instructions

Before operating the unit, please read this manual and supplied Quick Reference Manual thoroughly and retain it for future reference.

VPL-CH375/CH370/CH355/CH350

Not all models are available in all countries and area. Please check with your local Sony Authorized Dealer.



Table of Contents

Overview

| | |
|--|---|
| Location and Function of Controls | 4 |
| Main Unit | 4 |
| Connector Panel | 5 |
| Remote Commander and Control Panel Keys | 7 |

Preparation

| | |
|---|----|
| Connecting the Projector | 9 |
| Connecting a Computer | 9 |
| Connecting a Video equipment | 11 |
| Connecting a HDBaseT™ equipment | 13 |
| Connecting a microphone | 15 |
| Connecting an External Monitor and Audio Equipment | 16 |

Projecting/Adjusting an Image

| | |
|-----------------------------------|----|
| Projecting an Image | 17 |
| Adjusting the Projected image ... | 18 |
| Turning Off the Power | 23 |

Adjustments and Settings Using a Menu

| | |
|---------------------------------|----|
| Using a MENU | 24 |
| The Picture Menu | 25 |
| The Screen Menu | 26 |
| The Function Menu | 29 |
| The Operation Menu | 30 |
| The Connection/Power Menu | 31 |
| The Installation Menu | 34 |
| The Information Menu | 36 |

Network

| | |
|---|----|
| Using Network Features | 37 |
| Displaying the Control Window of the Projector with a Web Browser | 37 |
| Confirming the Information regarding the Projector | 38 |
| Operating the Projector from a Computer | 39 |
| Using the e-mail report Function | 39 |
| Setting the LAN Network of the projector | 40 |
| Setting the WLAN Network of the projector | 41 |
| Setting the Custom Labels for the Input Connectors of the Projector | 43 |
| Setting the Control Protocol of the Projector | 44 |

Presentation Function via Network

| | |
|--|----|
| Using Presentation Function via Network | 47 |
| Installing Projector Station for Network Presentation | 47 |
| Starting Projector Station for Network Presentation | 47 |
| Projecting an Image | 48 |
| Connection Settings | 49 |
| Using the Controller | 49 |
| Displaying Images or Files Sent from a Tablet PC/Smartphone | 50 |

Playing Video and Audio using USB Connection

| | |
|--|----|
| Playing Video and Audio using USB Connection | 51 |
| Starting USB Display | 51 |
| Playing Video and Audio | 51 |
| Using the Controller | 51 |

Others

| | |
|---|----|
| Indicators | 53 |
| Messages List | 54 |
| Troubleshooting | 55 |
| Replacing the Lamp | 58 |
| Cleaning the Air Filter | 60 |
| Specifications | 61 |
| Projection Distance and Lens Shift Range | 67 |
| Dimensions | 70 |
| END USER LICENSE AGREEMENT | 72 |
| Index | 78 |

Location and Function of Controls

Main Unit

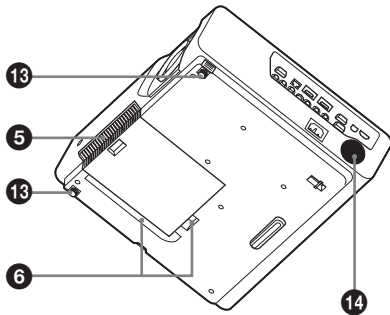
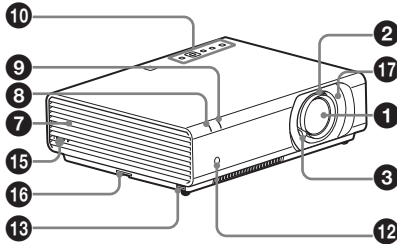

- 1 Projection lens
- 2 Focus ring (page 18)
- 3 Zoom lever (page 18)
- 4 Lamp cover (page 58)
- 5 Air filter cover/Ventilation holes (intake) (page 60)
- 6 Ventilation holes (intake) (page 60)
- 7 Ventilation holes (exhaust)

Caution

Do not place anything near the ventilation holes as this may cause internal heat buildup. Do not place your hand or deformable items (plastic, etc.) near the ventilation holes or around the projector, as it may cause damage or personal injury.

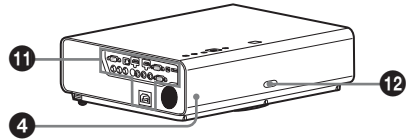

- 8 ON/STANDBY indicator (page 53)
- 9 LAMP/COVER indicator (page 53)
- 10 Control panel (page 7)
- 11 Connector panel (page 5)
- 12 Remote control detector
- 13 Front feet (adjustable) (page 20)
- 14 Speaker
- 15 Security lock

Connects to an optional security cable manufactured by Kensington. For details, visit Kensington's web site. <http://www.kensington.com/>

- 16 Security bar
- Connects to a commercially available security chain or wire. If it is difficult to pull out, pull out the Security bar using a screwdriver.

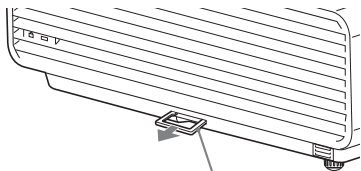

Security bar

- 17 Lens shift cover (page 19)
- For lens shift adjusting, remove this to access the lens shift screws inside the unit.

Connector Panel

VPL-CH375/CH355

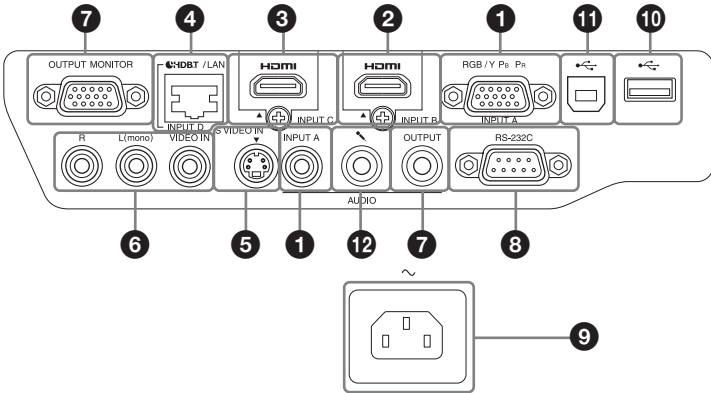

VPL-CH370/CH350

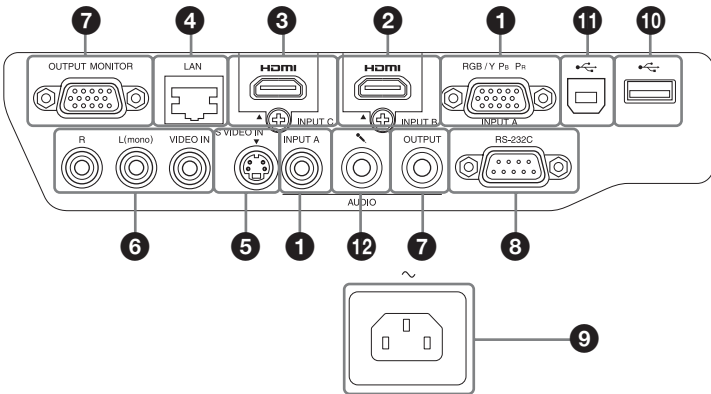

Input (pages 9, 11)

1 INPUT A

Video: RGB/YPbPr input connector (RGB/YPbPr)
 Audio: Audio input connector (AUDIO)

2 INPUT B

Video: HDMI input connector (HDMI)
 Audio: HDMI input connector (HDMI)

3 INPUT C

Video: HDMI input connector (HDMI)
 Audio: HDMI input connector (HDMI)

4 INPUT D

HDBaseT connector*/LAN connector (page 37)
 Use a straight CAT5e or CAT6 shielded LAN cable (not supplied).
 * VPL-CH375/CH355 only

5 S VIDEO (S VIDEO IN)

Video: S video input connector (S VIDEO IN)
 Audio: Audio input connector (L (MONO) AUDIO/R)

6 VIDEO (VIDEO IN)

Video: Video input connector (VIDEO)

Audio: Audio input connector
(L (MONO) AUDIO/R)

Note

The audio inputs of S VIDEO and VIDEO are shared.

Output (page 16)

7 OUTPUT

Video: Monitor output connector
(MONITOR)

Audio: Audio output connector
(AUDIO)

Notes

- This connector outputs the projected image only when INPUT A is used.
- When the speaker setting is set to “Always On” and the lamp is turned off, the audio of INPUT A and the microphone are enabled.

Others

8 RS-232C connector (RS-232C)

RS-232C compatible control connector.
Connects the computer’s RS-232C
connector and the RS-232C cross cables.

9 AC IN (~) socket

Connects the supplied AC power cord.

10 USB connector (Type A) () (page 11)

11 USB connector (Type B) () (page 51)

12 Microphone input ()

Remote Commander and Control Panel Keys

Remote Commander

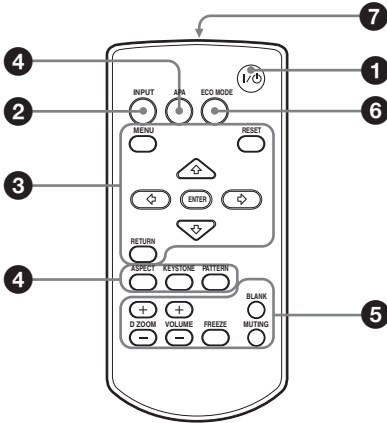

Control Panel Keys

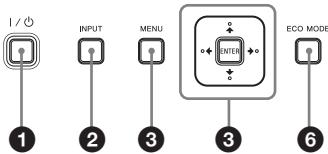

1 Turning on the power/Going to standby mode
I/⏻ (On/Standby) key

2 Selecting an input signal
(page 17)
INPUT key

3 Operating a menu (page 24)
MENU key
RESET key
ENTER /▲/▼/◀/▶ (arrow) keys
RETURN key

4 Adjusting the image (page 18)
ASPECT key (page 26)
KEystone key (page 20)
PATTERN key (page 22)
APA (Auto Pixel Alignment) key*
(page 22)

Note

* Use this key when inputting a computer signal via the RGB input connector (INPUT A).

5 Using various functions during projecting

D ZOOM (Digital Zoom)

+/- key*¹*²

Enlarges a portion of the image while projecting.

1 Press the D ZOOM + key to display the digital zoom icon on the projected image.

2 Press the ▲/▼/◀/▶ keys to move the digital zoom icon to the point on the image you want to enlarge.

3 Press the D ZOOM + key or the D ZOOM - key repeatedly to change the enlargement ratio. The image can be enlarged up to 4 times.

Press the RESET key to restore the previous image.

BLANK key

Cuts off the projected image temporarily. Press again to restore the previous image. Picture muting helps reduce power consumption.

MUTING key

Mutes the audio output temporarily. Press again to restore the previous volume.

VOLUME +/- key

Adjusts the volume output.

FREEZE key*²

Pauses a projected image. Press again to restore the image.

Notes

- *1: Use this key when inputting a computer signal. But it may not be used depending on the resolution of the input signal.
- *2: Use this key when inputting a computer signal. You cannot use this key when “Type B USB” or “Network” is selected as the input.

6 Setting the energy-saving mode easily

ECO MODE key

Energy-saving mode can be set easily. Energy-saving mode consists of “Lamp Mode,” “With No Input,” “With Static Signal” and “Standby Mode.”

- 1 Press the ECO MODE key to display the ECO Mode menu.

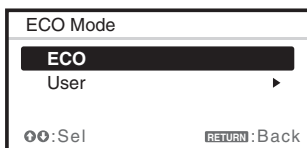

- 2 Press the \uparrow/\downarrow key or ECO MODE key to select “ECO” or “User” mode.

ECO: Sets each mode to the optimum energy-saving value.

Lamp Mode: Low

With No Input: Standby

With Static Signal: Lamp

Dimming

Standby Mode: Low

Speaker Setting: Sync with Power

User: Sets each item of the ECO

Mode menu as you desire (go to step 3).

- 3 Select “User” then press the \rightarrow key. The setting items appear.

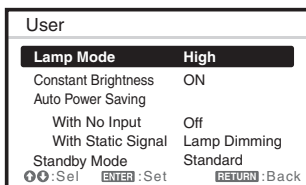

- 4 Press the \uparrow/\downarrow key to select the item then press the ENTER key.

- 5 Press the \uparrow/\downarrow key to select the setting value.
- 6 Press the ENTER key. The screen returns to the User screen. For details on each setting, see “Speaker Setting” in the Function menu (page 29), “Lamp Mode,” “Constant Brightness,” “With No Input,” “With Static Signal,” and “Standby Mode” in the Connection/Power menu (page 31).

Others

7 Infrared transmitter

About remote commander operation

- Direct the remote commander toward the remote control detector.
- The shorter the distance between the remote commander and the projector is, the wider the angle within which the remote commander can control the projector becomes.
- Make sure that nothing obstructs the infrared beam between the remote commander and the remote control detector on the projector.

Connecting the Projector

Notes

- Make sure all the equipment is powered off when connecting the projector.
- Use the proper cables for each connection.
- Insert the cable plugs firmly; Loose connections may reduce performance of picture signals or cause a malfunction. When pulling out a cable, be sure to grip it by the plug, not the cable itself.
- For more information, refer also to the instruction manuals of the equipment you are connecting.
- Use a no-resistance audio cable.

Connecting a Computer

Connection with a computer is explained for each input signal.

INPUT A

For connecting a computer with an RGB output connector.

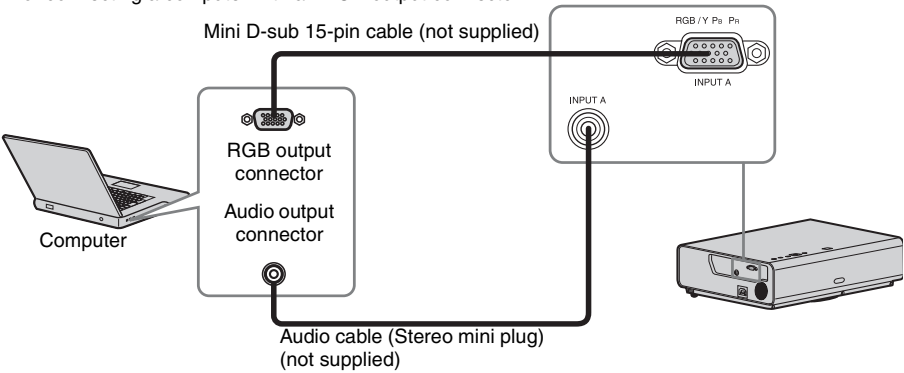

Note

It is recommended that you set the resolution of your computer to 1920 × 1200 pixels for the external monitor.

INPUT B/INPUT C

For connecting a computer with an HDMI output connector.

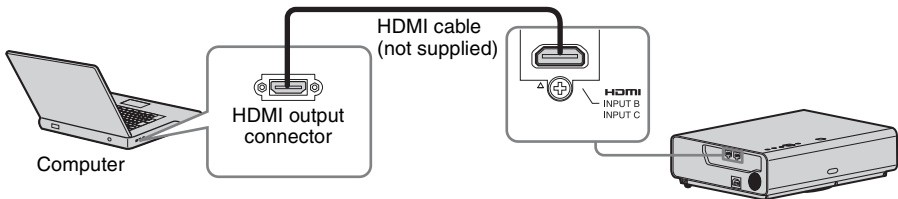

Notes

- Use HDMI-compatible equipment which has the HDMI Logo.
- Use a high speed HDMI cable(s) on which the cable type logo is specified. (Sony products are recommended.)
- The HDMI connector of this projector is not compatible with DSD (Direct Stream Digital) Signal or CEC (Consumer Electronics Control) Signal.

USB connector (Type B) (🔌)

For connecting to a computer with a USB connector (“Playing Video and Audio using USB Connection” (page 51)).

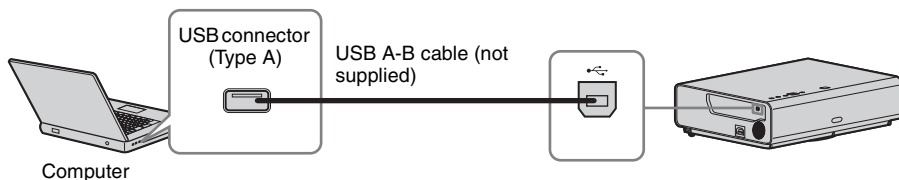

LAN connector

For connecting to a computer, tablet PC, or smartphone via a hub or router (“Presentation Function via Network” (page 47)).

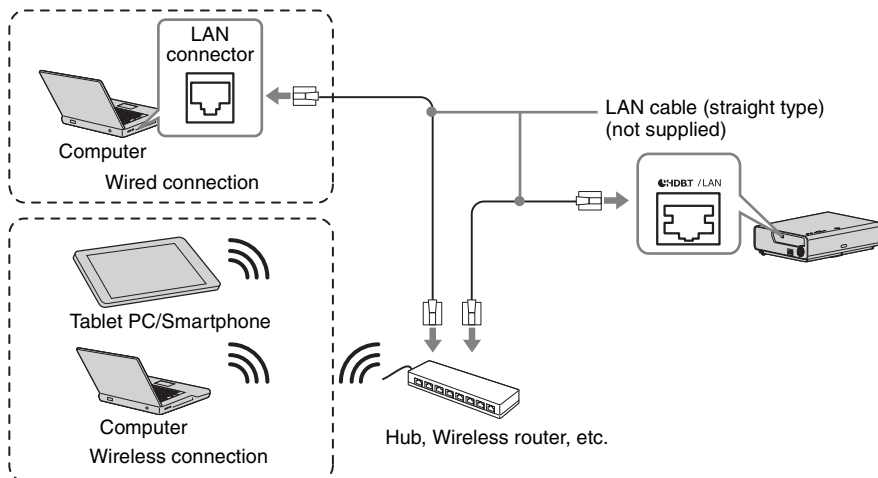

USB connector (Type A) ()

For connecting a USB wireless LAN module IFU-WLM3 (not supplied) (“Presentation Function via Network” (page 47)).

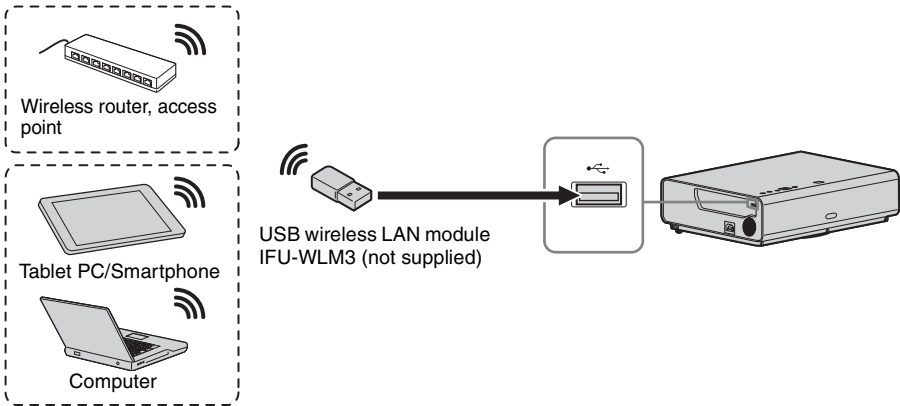

Notes

- Undesignated USB wireless LAN modules do not work.
- When connecting/disconnecting the USB wireless LAN module, make sure that the projector is in Standby mode (Standby Mode: “Low”), or the AC power cord is unplugged from the wall outlet.
- When wirelessly connecting a tablet PC/smartphone to the projector via USB wireless LAN module IFU-WLM3 (not supplied), set “WLAN Network” to “Access Pt. (Manual)” in the projector’s “WLAN Settings” (page 31).
- For connecting to the access point, access to the Web browser, and input the settings for the access point to connect. For details, see “Setting the WLAN Network of the projector” (page 41).

Connecting a Video equipment

Connections with a VHS video deck, DVD player, or BD player are explained for each input signal.

S VIDEO IN

For connecting video equipment with an S-video output connector.

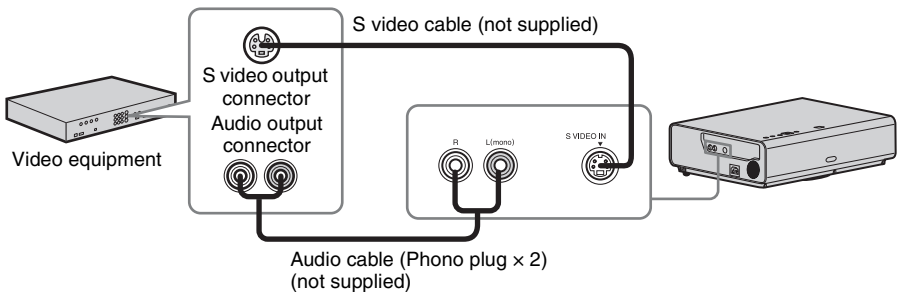

VIDEO IN

For connecting video equipment with a video output connector.

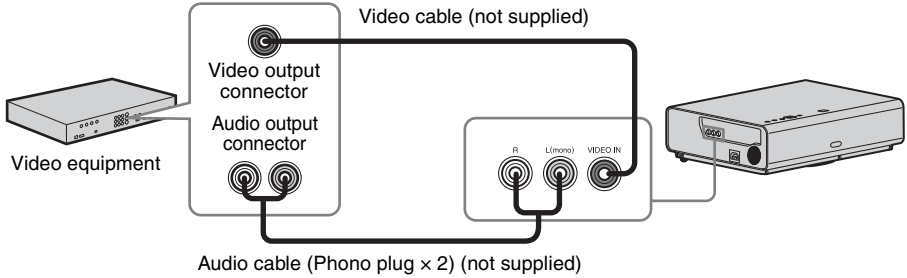

INPUT A

For connecting video equipment with a YPbPr output connector.

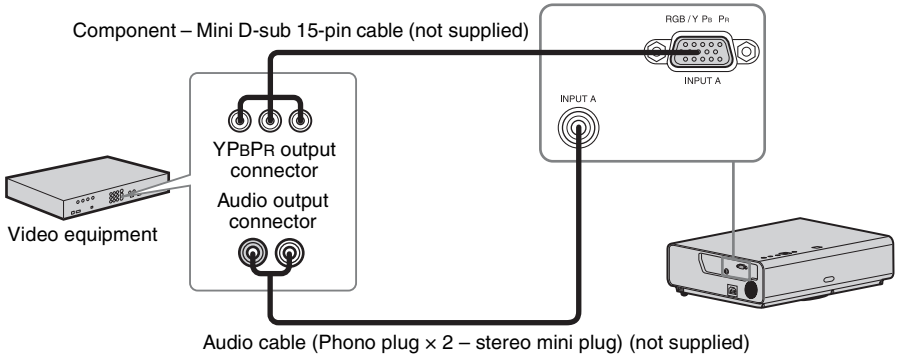

INPUT B/INPUT C

For connecting video equipment with an HDMI output connector.

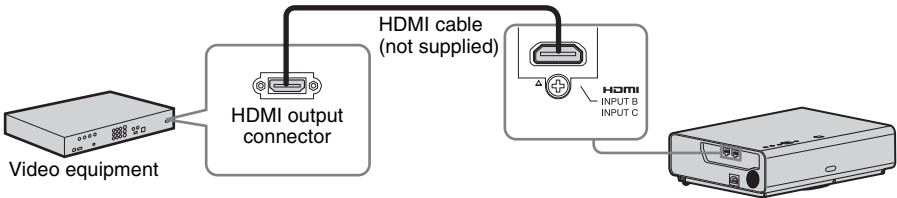

Notes

- Use HDMI-compatible equipment which has the HDMI Logo.
- Use a high speed HDMI cable(s) on which the cable type logo is specified. (Sony products are recommended.)
- The HDMI connector of this projector is not compatible with DSD (Direct Stream Digital) Signal or CEC (Consumer Electronics Control) Signal.

Connecting a HDBaseT™ equipment

For connecting the computer, video equipment, and network equipment via the HDBaseT transmitter.

Connecting to the computer

INPUT D

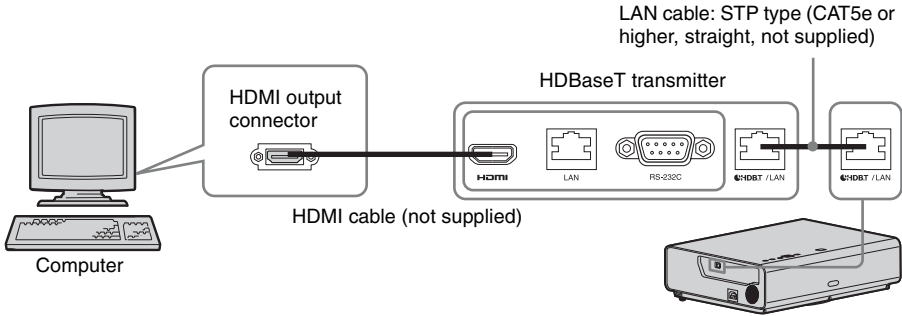

Preparation

Connecting to the video equipment

INPUT D

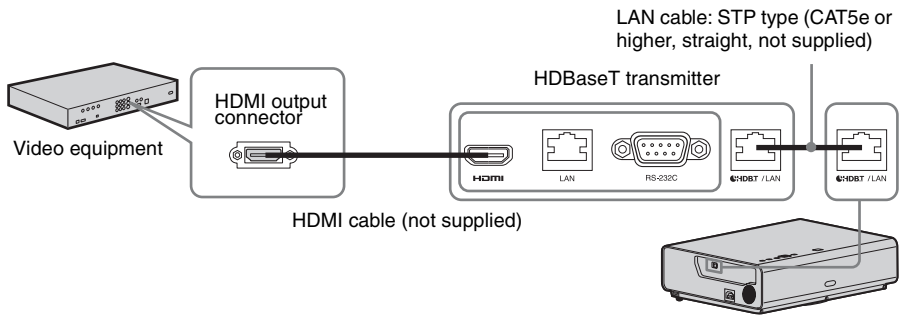

Notes for connecting this unit and the HDBaseT transmitter

- Ask a professional or Sony dealer to perform wiring. If wiring is not correct, the transmission characteristics of the cable will not be achieved, and image or sound may break up or you may experience unstable performance.
- Connect the cable directly to the HDBaseT transmitter without going through a hub or router.
- Use cables that meet the following conditions.
 - CAT5e or higher
 - Shielded type (covering connectors)
 - Straight wire connection
 - Single wire
- When installing the cables, use a cable tester, cable analyzer, or similar device to check if the cables meet the CAT5e or higher requirement. If there is a transit connector between this unit and the HDBaseT transmitter, include it when measuring.
- To reduce the affect of noise, install and use the cable in a manner where it is not rolled up and it is as straight as possible.
- Install the cable away from the other cables (especially the power cable).

- When installing multiple cables, do not bind them and keep the running parallel distance as short as possible.
- The transmittable distance of the cable is 100 m (approx. 328 feet) maximum. If it exceeds 100 m (approx. 328 feet), it may cause the image or the sound to break up, or cause a multifunction in LAN communication. Do not use the HDBaseT transmitter beyond the transmittable distance.
- Inquire about operation or function problems caused by other manufacturer's devices with the relevant manufacturer.

Connecting to the network equipment

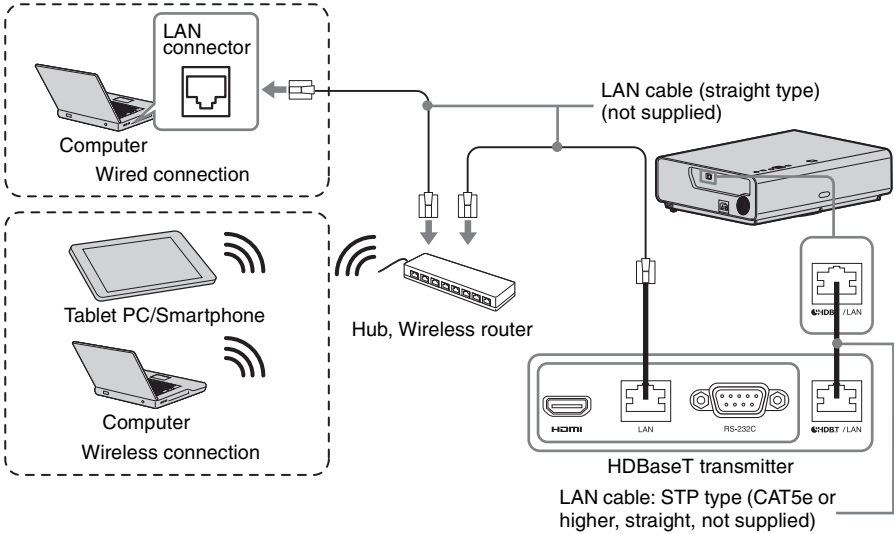

Note

Connect this unit and the HDBaseT transmitter without a hub or router between them.

To attach the HDMI cable

Fix the cable to the cable tie holder at the bottom of the projector, using a commercially available cable tie, as in the illustration.

Use a cable tie of less than 1.9 mm × 3.8 mm in thickness.

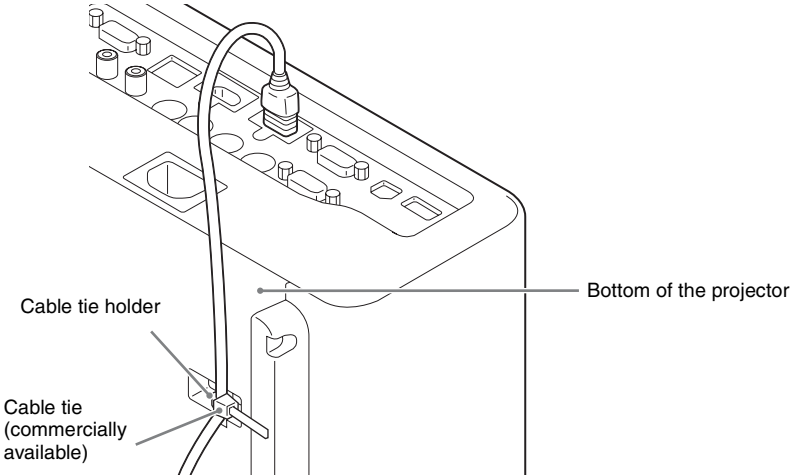

Connecting a microphone

Microphone (🎤)

For connecting a microphone.



Note

Only dynamic microphones are supported.

Connecting an External Monitor and Audio Equipment

OUTPUT

Projected images or input audio can be output to display equipment such as a monitor or audio equipment such as speakers with a built-in amplifier.

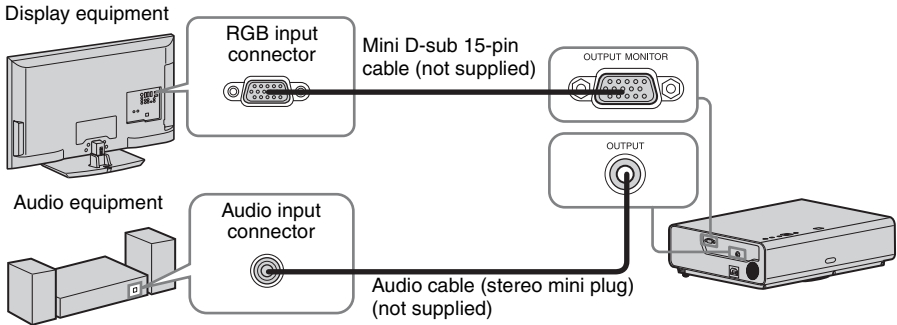

Notes

- Projected images can be output from INPUT A only.
- When the speaker setting is set to “Always On” and the lamp is turned off, the audio of INPUT A and the microphone are enabled.

Projecting an Image

The size of a projected image depends on the distance between the projector and screen. Install the projector so that the projected image fits the screen size. For details on projection distances and projected image sizes, see “Projection Distance and Lens Shift Range” (page 67).

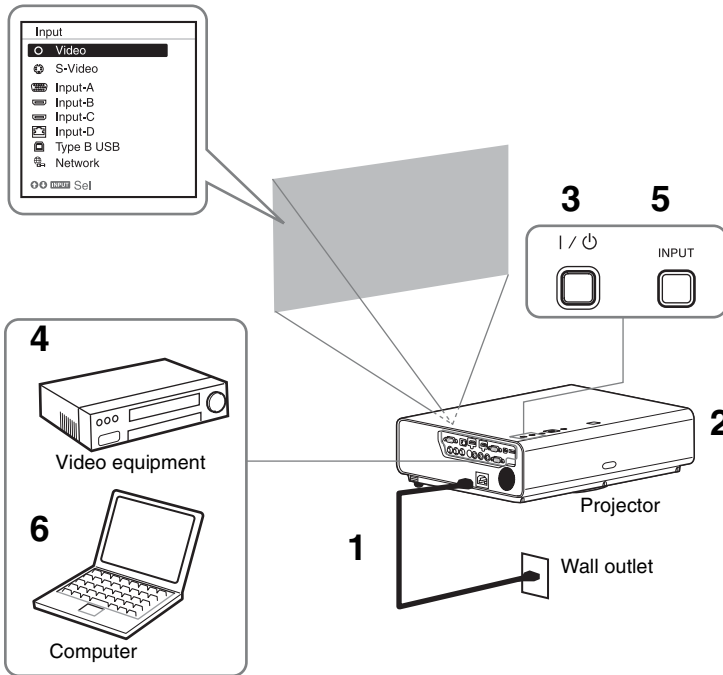

Projecting/Adjusting an Image

1 Plug the AC power cord into the wall outlet.

2 Connect all equipment to the projector (page 9).

3 Press the I/⏻ key to turn on the unit.

4 Turn on the connected equipment.

5 Select the input source.
Press the INPUT key on the projector to display the menu for switching input signal on the screen. Press the INPUT key repeatedly, or press the ⬆/⬇ key to select an image to be projected.

6 When projecting a computer image, switch your computer's output to external display.
The method to switch the output varies depending on the type of computer.



(Example)



To play video and audio using USB Connection, see “Playing Video and Audio using USB Connection” (page 51). To use Presentation Function via Network, see “Presentation Function via Network” (page 47).

7 Adjust the focus, size and position of the projected image (page 18).

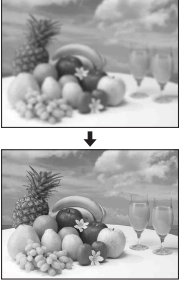
Adjusting the Projected image

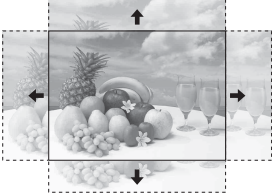
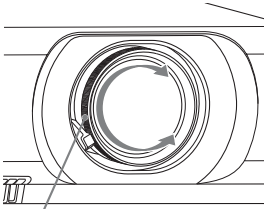
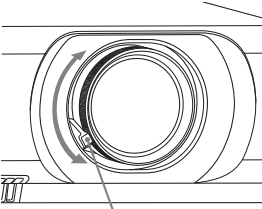
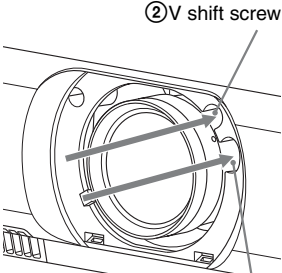
| Focus | Size (Zoom) | Position (Lens shift) |
|---|---|---|
|  |  |  |
|  <p data-bbox="135 810 230 836">Focus ring</p> |  <p data-bbox="512 821 613 847">Zoom lever</p> |  <p data-bbox="863 549 1003 574">② V shift screw</p> <p data-bbox="855 874 997 900">① H shift screw</p> |

Adjusting the tilt of the projector by lens shift

You can adjust the position of the projected image by turning the screws for lens shift (V shift screw and H shift screw).

- 1 Lift up the lower end of the lens shift cover with your finger to remove it.

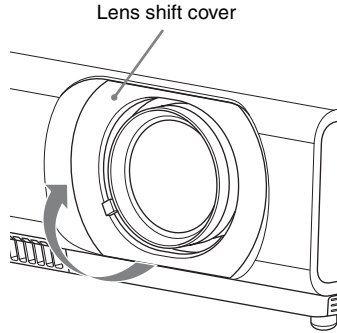

- 2 Insert a Philips screwdriver to the ①H shift screw inside the unit and turn it to adjust right or left, and to the ②V shift screw to adjust up or down. Be careful not to look into the lens.

Continued turning of these screws will return the lens shift to its original position. Adjust the screws to set the lens shift to the optimum position. For details on the adjustment range, see the “Lens shift range” (page 69).

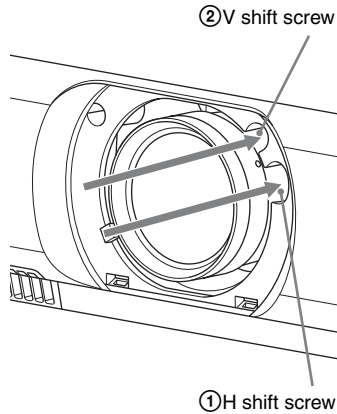

- 3 Return the lens shift cover to the unit.

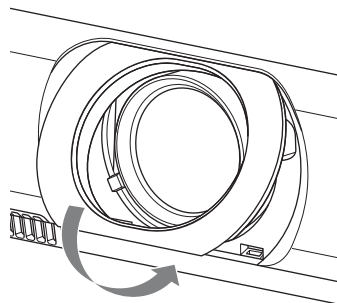

Adjusting the tilt of the projector with the front feet (adjustable)

You can adjust the height of the projector pushing the side button on this unit. By changing the slope of the projector with front feet (adjustable), you can adjust the position of the projected image.

How to alter the angle

- 1 Push in the foot adjust button at the side of the unit.
- 2 Keeping the button pushed in, raise the main unit to the desired angle.
- 3 Release the foot adjust button.
- 4 For fine positioning, turn the right and left front feet (adjustable) beneath the unit.

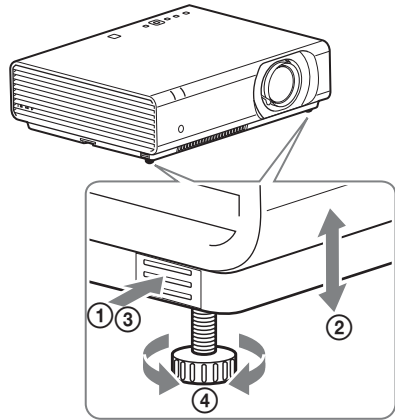

Notes

- Be careful not to let the projector down on your fingers.
- Do not push hard on the top of the projector with the front feet (adjustable) extended. It may cause malfunction.

Changing the aspect ratio of the projected image

Press ASPECT on the remote commander to change the aspect ratio of the projected image. You can also change the setting in Aspect of the Screen menu (pages 26, 28).

Correcting trapezoidal distortion of the projected image (Keystone feature)

If the image becomes trapezoidal, set the keystone manually.

When the projected image is a trapezoid, tapering to the top or bottom

- 1 Press KEYSTONE on the remote commander once or select V Keystone in the INSTALL SETTING menu.
- 2 Use ▲/▼/◆/◆ to set the value. The higher the setting, narrower the top of the projected image. The lower the setting, the narrower the bottom.

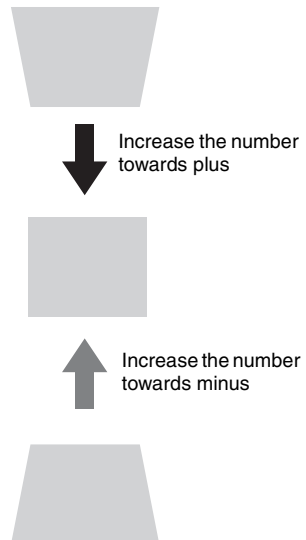

Press the RESET key to restore the projected image before adjustment.

When the projected image a trapezoid, tapering to the right or left

- 1 Press KEystone on the remote commander twice or select H Keystone in the INSTALL SETTING menu.
- 2 Use $\uparrow/\downarrow/\leftarrow/\rightarrow$ to set the value. The higher the setting, the narrower the right part of the projected image. The lower the setting, the narrower the left part.

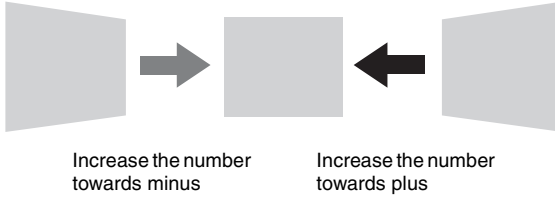

Press the RESET key to restore the projected image before adjustment.

Notes

- Since the Keystone adjustment is an electronic correction, the image may be deteriorated.
- Depending on the position adjusted with the lens shift feature, the aspect ratio of the image may change from the original or projected image may be distorted with Keystone adjustment.

Correcting the image twist (Corner Keystone feature)

You can correct the image twist by the corner keystone feature.

- 1 Press KEystone on the remote commander three times, or select “Corner Keystone” in the INSTALL SETTING menu, and select “Adjust.”
- 2 The guide is displayed.

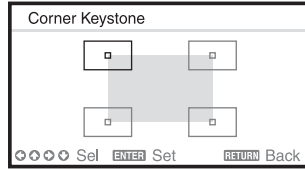

The corners of the image to be corrected

- 1 Move the \square by using $\uparrow/\downarrow/\leftarrow/\rightarrow$ to select the corner you want to correct. If you press ENTER, you will go back to the cursor display.

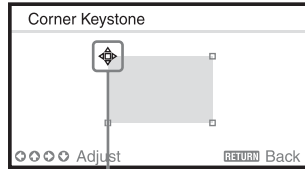

Adjust using this cursor.

- 2 Adjust the position of the corner you want to correct by using $\uparrow/\downarrow/\leftarrow/\rightarrow$.

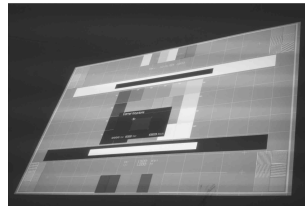

- 3 The cursor will disappear if the adjustment range limit is reached.

Example of cursor display:

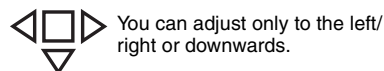
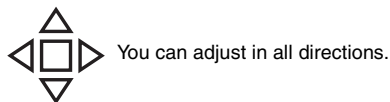

Press the RESET key to restore the projected image before adjustment.

Displaying a pattern

You can display a pattern for adjusting the projected image or a grid pattern with the PATTERN key on the remote commander. Press the PATTERN key again to restore the previous image. You can use a grid pattern as a guide to write text or to draw lines and shapes on the whiteboard or blackboard without using a computer.

Note

You cannot use this key when “Type B USB” or “Network” is selected as the input.

Automatically adjusts Phase, Pitch and Shift of projected image while a signal is input from a computer (APA (Auto Pixel Alignment))

Press the APA key on the remote commander. Press again to cancel adjusting during the setting. You can also set APA in the Screen Menu (page 26). If Smart APA in the Function menu is set to “On”, executes APA automatically when a signal is input (page 29).

Turning Off the Power

- 1 Press the I/⏻ key on the unit or the remote commander.
The projector starts shutdown and turns off. If you press the I/⏻ key within 10 seconds again, shutdown is cancelled.

Note

Do not turn off the projector soon after the lamp lights. It may cause a malfunction of the lamp (does not light ,etc.).

- 2 Unplug the AC power cord from the wall outlet.

To turn off without displaying confirmation message

Press and hold the I/⏻ key on the unit for a few seconds (page 54).

ECO gauge

This gauge indicates the current effectiveness of the projector's ECO function. (For details on the ECO function, see "ECO MODE key" (page 8) and "ECO" (page 31).)

The leaf icons are displayed when the projector is shut down. The number of displayed icons varies according to how much energy is saved as a result of using the ECO function.



Using a MENU

Note

The menu displays used for the explanation below may be different depending on the model you are using.

- 1 Press the MENU key to display the menu.
- 2 Select the setting menu.
Use the \uparrow/\downarrow key to select the setting menu then press the \rightarrow key or ENTER key.

Setting menu

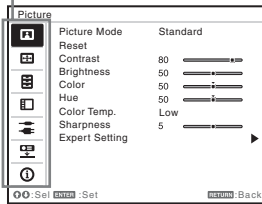

- 3 Select the setting item.
Use the \uparrow/\downarrow key to select the setting menu then press the \rightarrow key or ENTER key.
To return to the selection screen of the setting menu, press the \leftarrow or RETURN key.

Setting items

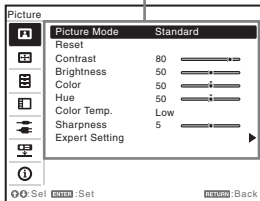

- 4 Make the setting or adjustment for the selected item.
The setting method varies, depending on the setting item.
If the next menu window is displayed, select the item according to the

operations in step 3 and then press the ENTER key to register the setting.
To return to the selection screen of the setting items, press the \leftarrow or RETURN key. You can press the RESET key to reset an item to its factory setting value to aid setting.

Using a pop-up menu

Press the $\uparrow/\downarrow/\leftarrow/\rightarrow$ key to select an item. Selected items take effect immediately, except “Language,” “Speaker Setting,” and “Input-A Signal Sel.,” which take effect after you press the ENTER key.

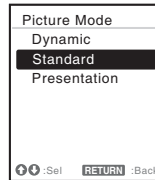

Using the setting menu

Press the \uparrow/\downarrow key to select the item.
Press the ENTER key to register the setting and return to the previous screen.

Using the adjustment menu

To increase the value, press the \uparrow/\rightarrow key and to decrease the number, press the \downarrow/\leftarrow key. Press the ENTER key to register the setting and return to the previous screen.

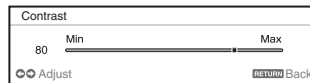

- 5 Press the MENU key to clear the menu.
The menu disappears automatically if no operation is performed.

The Picture Menu

The Picture is used to adjust the picture for each input signal.

| Items | Item descriptions |
|---------------------------|---|
| Picture Mode | Dynamic: Emphasizes the contrast to produce a dynamic and vivid picture. Standard: Provides an image which is natural and well balanced. Presentation: Provides a bright image, suitable for presentations. |
| Reset ^{*1} | Resets the factory setting. |
| Contrast | The higher the value, the greater the contrast. The lower the value, the lower the contrast. |
| Brightness | The higher the value, the brighter the picture. The lower the value, the darker the picture. |
| Color ^{*2 *3} | The higher the value, the greater the intensity. The lower the value, the lower the intensity. |
| Hue ^{*2 *3 *4} | The higher the value, the more greenish the picture becomes. The lower the value, the more reddish the picture becomes. |
| Color Temp. ^{*5} | High/Middle/Low: The higher the value, the more bluish the picture. The lower the value, the more reddish the picture. |
| Sharpness | The higher the value, the sharper the picture. The lower the value, the softer the picture. |
| Expert Setting | |
| Gamma Mode | Graphics1: Gamma correction to make halftones brighter. This setting is suitable when projecting highly colorful images, such as photos, in a bright place. Graphics2: Gamma correction to improve the reproduction of halftones. Highly colorful images, such as photos, can be reproduced in natural tones. Text: Improves black and white contrast. Suitable for images with lots of text content. DICOM GSDF Sim. ^{*6:} Gamma setting is in accordance with the Grayscale Standard Display Function (GSDF) of the Digital Imaging and Communications in Medicine (DICOM) standards. |

Notes

- *1: The settings in the Picture return to their factory defaults, except for Picture Mode.
- *2: When a video signal is input, this option is available.
- *3: When the signal without color burst signal is input after selecting “Video” or “S-Video”, this option is unavailable.
- *4: When an analog TV signal is input, this option may not available, depending on the color system.
- *5: When “Picture Mode” is set to the item other than “Presentation,” this option is available.
- *6: Available when a computer signal is input from the DVI-D input connector (INPUT C) and HDMI input connector (INPUT D). This projector is not to be used as a device for medical diagnosis.

The Screen Menu

The Screen menu is used to adjust the size, position and aspect ratio of the projected image for each input signal.

| Items | Item descriptions |
|-----------------------------------|--|
| Aspect ^{*1} | Changes the aspect ratio of the projected image (page 28). |
| When the computer signal is input | 4:3: Displays the image to fit the maximum projected image size with an aspect ratio fixed to 4:3. 16:9: Displays the image to fit the maximum projected image size with an aspect ratio fixed to 16:9. Full 1: Displays the image to fit the maximum projected image size without changing the aspect ratio of the input signal. Full 2: Displays the image to fit the maximum projected image size changing the aspect ratio of the input signal. Full 3: Displays the image to fit the maximum width or height, up to 1920 × 1080 pixels, without changing the aspect ratio of the input signal. Normal: Displays the image on the center position of the projected screen without changing the resolution of the input signal or enlarging the image. |
| When the video signal is input | 4:3: Displays the image to fit the maximum projected image size with an aspect ratio fixed to 4:3. 16:9: Displays the image to fit the maximum projected image size with an aspect ratio fixed to 16:9. Full: Displays the image to fit the maximum projected image size changing the aspect ratio of the input signal. Zoom: Zooms the center area of a projected image. |
| Adjust Signal | Adjusts the image of computer signal. Use this item if the edge of the image is cut and reception is bad. |
| APA ^{*2 *3} | Automatically adjusts the projected image to an optimum quality when you press the ENTER key (page 7). |
| Phase ^{*2} | Adjusts the dot phase of the display pixel and the input signal. Set to the value where looks clearest. |
| Pitch ^{*2 *5} | The higher the value, the wider the horizontal image elements (pitch). The lower the value, the narrower the horizontal image elements (pitch). |
| Shift ^{*4} | H (Horizontal): The higher the value, the farther right the image is projected on the screen. The lower the value, the image farther left. V (Vertical): The higher the value, the farther up the image is projected on the screen. The lower the value, the image farther down. |

Notes

- *1: • Note that if the projector is used for profit or for public viewing, modifying the original picture by switching to the aspect mode may constitute an infringement of the rights of authors or producers, which are legally protected.
- Depending on the input signal, setting items for aspect ratio or some other setting items cannot be set in some cases, or changing the aspect ratio setting may have no effect.

- A part of the image may be displayed in black, depending on the setting item.
- *2: Available when a computer signal is input from the RGB input connector (INPUT A).
- *3: If the projected image includes large amount of black portion around it, the APA function will not work properly and a part of the image may not be displayed on the screen and also optimum image cannot be obtained, depending on the type of input signal. In this case, adjust the “Phase,” “Pitch,” and “Shift” items manually.
- *4: Available when a computer or a video signal is input from the RGB/YPbPr input connector (INPUT A).
- *5: When “APA” (page 26) or “Smart APA” (page 29) is performed, the adjusted value for “Pitch” will return to its factory default. If you want to continue using the adjusted value, set “Smart APA” to “Off.”

Aspect

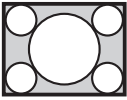
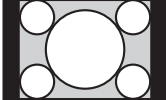
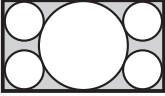
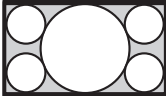
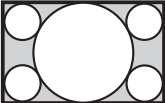
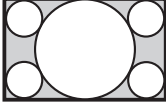
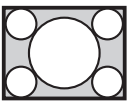
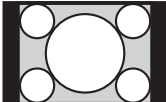
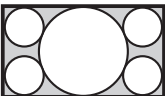
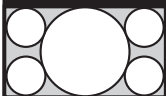
| | Input signal | Recommended setting value and projected image |
|-----------------|--|---|
| Computer signal | 4:3  | Full1 *1 *2 *3  |
| | 16:9  | Full1 *1 *2 *3  |
| | 16:10  | Full1 *3  |
| Video signal | 4:3  | 4:3 *4 *5  |
| | 16:9  | 16:9  |

*1: If you select “Normal,” the image is projected in the same resolution as the input signal without changing the aspect ratio of the original image.



*2: If you select “Full2,” the image is projected to fit the projected image size, regardless of the aspect ratio of the image.

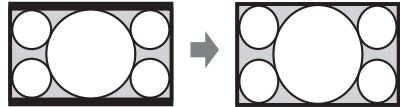

*3: If you adjust the projected image position using an image with 16:9 aspect ratio and then switch the input source to 4:3 image, the top and bottom edge of the image may be hidden. In this a case, select “Full3.”

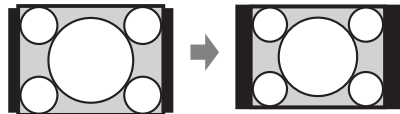

*4: Depending on the input signal, the projected image may be projected as illustrated below. In this a case, select “16:9.”



*5: Depending on the input signal, the image may be projected as illustrated below. In this a case, select “Zoom.”



The Function Menu

The Function menu is used for setting various functions of the projector.









| Items | Item descriptions |
|------------------|--|
| Volume | The higher the value, the louder an audio volume and the lower the value, the lower the audio volume. |
| Mic Volume | Adjust the volume of the microphone.*2 |
| Speaker | On/Off: When set to “On,” speaker outputs sound. To not output sound from the speaker, select “Off.” |
| Speaker Setting | Sync with Power/Always On: When set to “Always On,” the speaker is available even in Lamp Cutoff.*3 |
| Smart APA | On/Off: When set to “On,” APA functions automatically when a signal is input.*1 |
| CC Display | CC1/CC2/CC3/CC4/Text1/Text2/Text3/Text4: Select the closed caption service (captions or text). Off: Closed caption does not appear. |
| Lamp Timer Reset | When replacing the lamp, resets the lamp timer (page 58). |
| Start Up Image | On/Off: When set to “On,” the Start Up Image is displayed on the screen when the projector is powered on. |
| All Reset | Resets all settings to their factory defaults. |

Notes

- *1: APA functions when a computer signal is input via the RGB input connector (INPUT A).
- *2: The maximum available mic volume is set by the value of “Volume.”
- *3: When the speaker setting is set to “Always On” and the lamp is off, the audio of INPUT A and the microphone are enabled.
If “Always On” is selected, “Eco Mode” will be set to “User,” “Standby Mode” will be set to “Standard” in conjunction.

The Operation Menu

The Operation menu is used for setting for the operations by using the menu or the Remote Commander.

| Setting items | Description |
|-----------------------------|---|
| Language | Selects the language used in the menu and on-screen displays. |
| Menu Position | Bottom Left/Center: For selecting the position of the menu displayed on the projected image. |
| Status | On: All on-screen statuses are enabled. Off: Displays only the menus, the message when turning off the power, and warning messages. |
| IR Receiver | Front & Rear/Front/Rear: Selects the remote control detectors (IR Receiver) on the front and rear of the projector. |
| Security Lock ^{*1} | On/Off: This function enables restriction of the projector to authorized users by password. The setting procedures for security locking are as follows: 1 Select “On” then press the ENTER key to display the setting menu. 2 Input the password with the MENU,  ,  ,  , and ENTER keys. (The default password setting is “ENTER, ENTER, ENTER, ENTER.”) 3 Input a new password with the MENU,  ,  ,  , and ENTER keys. 4 Enter the password again to confirm. Enter the password when you turn on the projector after disconnecting and reconnecting the AC power cord. When it is set to “Off,” you can cancel the security lock. You are required to input the password again. If you fail to enter the correct password after three consecutive times, the projector cannot be used. In this case, press the  key to go standby mode then turn on the power again. |
| Control Key Lock | On/Off: When set to “On,” locks all the control panel keys of the projector. However, you can operate the following when set to “On”: <ul style="list-style-type: none">• Press and hold the  key for approximately 10 seconds during Standby mode. → The projector turns on.• Press and hold the MENU key for approximately 10 seconds during power on. → “Control Key Lock” is set to “Off” and enables operation of all keys on the projector. |

Note

*1: You will not be able to use the projector if you forget your password. If you call qualified Sony personnel because you have forgotten the password, you will be asked to verify the projector’s serial number and your identity. (This process may differ in other countries/regions.) Once your identity has been confirmed, we will provide you with the password.

The Connection/Power Menu

The Connection/Power menu is used for setting for the connections and power.

| Items | Item descriptions |
|--------------------------------|--|
| LAN Settings | |
| IP Address Setup ^{*9} | Auto (DHCP): The IP address is assigned automatically from the DHCP server such as a router. Manual: To specify the IP Address manually. |
| WLAN Settings ^{*10} | |
| WLAN Connection ^{*8} | On/Off: Set the wireless output of the USB wireless LAN module (not supplied) to On/Off. |
| WLAN Network ^{*14} | Access Pt. (Auto)/Access Pt. (Manual)/Client^{*11}: Changes modes for WLAN. ^{*12} |
| Network Presentation | |
| Connection CODE | On/Off: This is the presentation function via the network. It controls the connection using the displayed number (CODE) on the right bottom of the screen. During the image transmission, using the ENTER key on the remote commander makes Connection CODE display again. |
| HDBaseT setting | |
| HDBaseT/LAN connector | HDBaseT: Connecting the HDBaseT transmitter and the LAN cable enables transmitting the signal of the Video, Audio, Ethernet, and RS-232C. LAN: Connecting the LAN cable for Ethernet directly enables connecting to the network. (Use when connecting the cable directly without the HDBaseT transmitter.) |
| RS-232C setting | Via HDBaseT: You can connect this unit to the RS-232C connector via the HDBaseT transmitter. (Baud rate: 9600bps) RS-232C connector: Use when connecting to the RS-232C connector of this unit directly. |
| Dynamic Range ^{*16} | Sets the image input level of the INPUT B/C/D connector. ^{*17} Auto: Distinguishes the image input level automatically. Limited: Set when the image input level is 16-235. Full: Set when the image input level is 0-255. |
| Input-A Signal Sel. | Auto/Computer/Video GBR/Component: When set to “Auto,” selects the type of video signal input automatically when “Input-A” is selected. ^{*1} |
| ECO | |
| Lamp Mode | High/Standard/Low/Auto^{*5 *15}: When set to “High,” the image becomes brighter, and power consumption becomes higher. When set to “Low,” power consumption is minimized; however, the image will be darker. When set to “Auto,” brightness is adjusted automatically according to image content. Dark images are projected with brightness adjusted, leading to energy-saving. Bright images are projected brightly, without adjusting brightness. |
| Constant Brightness | On/Off: Available when the lamp mode is set to High . Outputs light at a certain brightness. ^{*13} |

| Items | Item descriptions |
|--------------------|---|
| Auto Power Saving | |
| With No Input | Lamp Cutoff: The lamp turns off automatically and power consumption is reduced if no signal is input for more than 10 minutes. The lamp lights again when a signal is input or any key is pressed. In Lamp Cutoff, the ON/STANDBY indicator lights in orange. (page 53) Standby *6: If no signal is input to the unit for more than 10 minutes, the power turns off automatically, and the unit enters standby mode. Off: You can deactivate the With No Input. |
| With Static Signal | Lamp Dimming *4 *5 *7: If an image does not change for about 10 seconds, lamp output is gradually reduced (approximately 10% to 15%*3) from that set in the Lamp Mode. Automatically the lamp slowly darkens to approximately 30% of its lamp output according to the selected time (with no change to input signal) “5,” “10,” “15,” “20” minutes or “ Demo. ” While dimming the lamp, the message “Lamp Dimming” appears. If you select “Demo.,” the image will start to darken about 40 seconds later. When any change in signal is detected, or an operation (remote control or control panel) is performed, normal brightness is restored. Off: You can deactivate the With Static Signal. |
| Standby Mode*2 | Standard/Low: When set to “Low,” lowers power consumption in Standby mode. |
| Direct Power On | On/Off: When set to “On,” you can turn the power on without going to Standby mode when the AC power cord is connected to a wall outlet. With the projector turned off, you can also unplug the AC power cord without going to Standby mode, regardless of the Direct Power On setting. |





Notes

- *1: This may not be optimum depending on the input signal. In this case set manually according to the connected equipment.
- *2: When “Standby Mode” is set to “Low,” the network and network control function cannot be operated while the projector is in standby mode.
- *3: This varies depending on the “Lamp Mode” setting.
- *4: As the lamp is dimmed gradually, you may not notice any change in brightness. You might only notice that the lamp has dimmed when its brightness is restored after there is a change in input signal.
- *5: This mode does not work for about three minutes after the lamp lights. A change in signal may not be detected depending on the input image. The lamp may become brighter at intervals during lamp dimming. However, this is not a malfunction. If With No Input is set, it takes priority.
- *6: Select “Off” to avoid entering standby mode when there is no input signal.
- *7: Does not function when “Type B USB” or “Network” is selected as the input.
- *8: Reflecting changes in WLAN settings may take a few moments.
- *9: To set the IP address manually, select “Manual”, press “Apply”, then enter the IP address.
- *10: When you send images or files from a tablet PC/smartphone and display them (page 50), set “WLAN Network” to “Access Pt. (Auto)” or “Access Pt. (Manual),” to use USB wireless LAN module IFU-WLM3 (not supplied) as a wireless access point.

- *11: The factory default settings for “Access Pt. (Manual)” are as follows.
SSID: VPL + MAC address for LAN
Security Method: WEP(64bit)
Wireless Password: sony1
To change the settings for “Access Pt. (Manual)”, use a Web browser.
For details, see “Setting the WLAN Network of the projector” (page 41).
- *12: For changing the settings for “Client,” use the Web browser for change. For details, see “Setting the WLAN Network of the projector” (page 41).
- *13: Constant Brightness mode will be enabled for about 2,000 hours after it is activated at early usage. After this period, it will be disabled automatically. Activated time and brightness may vary depending on the usage conditions.
- *14: If the projector cannot connect wirelessly, click [Apply] once again to make sure the connection is established. For details, see “Setting the WLAN Network of the projector” (page 41).
- *15: Does not function when “Type B USB” or “Network” is selected as the input. In this case, it becomes equivalent to “Standard.” Cannot be selected by VPL-CH355/CH350.
- *16: If the image input setting of the HDMI connection equipment is not correct, the brighter part becomes too bright and the darker part becomes too dark.
- *17: The INPUT D connector is available on VPL-CH375/CH355 only.

The Installation Menu

The Installation menu is used for installing the projector.

| Items | Item descriptions |
|-------------------------------|---|
| Screen Fitting | HV Keystone/ Corner Keystone: You can choose how to correct image twist. |
| V Keystone ^{*1} | This is displayed when “HV Keystone” is selected in “Screen Fitting.” Auto/Manual: The higher the setting, the narrower the top of the projected image. The lower the setting, the narrower the bottom of the projected image. |
| H Keystone ^{*1} | This is displayed when “HV Keystone” is selected in “Screen Fitting.” The higher the setting, the narrower the right side of the projected image. The lower the setting, the narrower the left side of the projected image. |
| Corner Keystone ^{*1} | This is displayed when “Corner Keystone” is selected in “Screen Fitting.” Adjust: Corrects image twist. Reset: Resets the adjusted values to their default values. |
| Image Flip | HV/H/V/Off: Flips the projected image horizontally and/or vertically according to the installation method. |
| Installation Attitude | Link to Image Flip/Right Side Up/Upside Down: Change the cooling setting to suit to the installation attitude. When set to “Link to Image Flip,” the cooling setting changes based on the setting of “Image Flip.” Continuing to use the wrong setting may affect component reliability. |
| High Altitude Mode | On/Off: Set to “On” when using the projector at an altitude of 1,500 m or higher. Continuing to use the wrong setting may affect component reliability. |
| Panel Alignment ^{*2} | This feature allows you to adjust the gaps in the color of characters or the picture. When set to “On,” “Adjust Color” and “Pattern Color” can be assigned and adjusted. Adjust Item: Selects how to make adjustments from below. Shift: Shifts the whole picture and makes adjustments. Zone: Selects the desired range and makes adjustments. Adjust Color: Assigns the desired color to adjust the gaps in color. Select “R” (Red) or “B” (Blue) to make adjustments based on “G” (Green). Pattern Color: Select “R/G” (Red and Green) or “R/G/B” (White, all colors) when “Adjust Color” is “R” (Red). Select “B/G” (Blue and Green) or “R/G/B” (White, all colors) when the “Adjust Color” is “B” (Blue). Adjust: The shift adjustment and zone adjustment of the color selected in “Adjust Color” can be made with  /  /  /  keys. Reset: The panel alignment settings are initialized to their factory preset values. |
| Color Matching ^{*3} | Adjust/Reset: For correcting the brightness and color of the whole projected image manually from the signal level in six steps. |

Notes

*1: Since the HV Keystone/Corner Keystone adjustment is an electronic correction, the image may deteriorate.

V Keystone: Even when set to “Auto,” you can adjust manually by the following steps.

- 1) Press the KEYSTONE key to display “V Keystone.”
 - 2) Adjust the values with the ▲/▼ keys to adjust manually temporarily.
If the projector is turned off, the setting will be restored to “Auto.”
- *2: Depending on the adjustment value of “Panel Alignment,” the color and resolution may be changed.
- *3: The brightness and color of the projected image may not match completely, even after you adjust “Brightness” and “Color.”

The Information Menu

The Information menu is used to check projector status, such as total usage time of the lamp.

| Items | Item descriptions |
|---------------------|---|
| Model Name | Displays the model name. |
| Serial No. | Displays the serial number. |
| fH/fV ^{*1} | Displays the horizontal/vertical frequency of the current input signal. |
| Signal Type | Displays the type of the current input signal. |
| Lamp Timer | Indicates the total usage time of a lamp. |

Note

*1: These items may not be displayed depending on the input signal.

Using Network Features

Connection to the network allows you to operate the following features:

- Checking the current status of the projector via a Web browser.
- Remotely controlling the projector via a Web browser.
- Receiving the e-mail report via the projector.
- Making the network settings for the projector.
- Displaying messages on the projected image using an application.
- Supports network monitoring, control protocol (Advertisement, PJ Talk, PJ Link, AMX DDDP [Dynamic Device Discovery Protocol], Crestron RoomView).

Notes

- When connecting this projector with the network, consult with the network administrator. The network must be secured.
- The content communicated via a wireless LAN communication may be intercepted due to the use of radio waves. To protect the communication content, implement security measures properly according to the connection environment (page 41).
- When using this projector connected with the network, access the Control window via a Web browser and change the access limitation of the factory preset values (page 38). It is recommended to change the password regularly.
- When the setting on the Web browser is completed, close the Web browser to log out.
- The menu displays used for the explanation below may be different depending on the model you are using.
- Supported Web browsers are Internet Explorer 8/9/10/11.
- The menu displays only in English.
- If the browser of your computer is set to [Use a proxy server] when you access to the projector from your computer, click the check mark to set accessing without using a proxy server.
- To display messages, specific application Projector Station for Network Control (Version 1.1 or later) is necessary. For download or detailed method of using Projector Station for Network Control, please access the following URL.
<http://pro.sony.com/bbsc/ssr/cat-projectors/resource.downloads>
Contact your local Sony dealer for detailed information of Projector Station for Network Control.

Displaying the Control Window of the Projector with a Web Browser

- 1** Connect the LAN cable (page 10).
- 2** Set the network settings for the projector using “LAN Settings” on the Connection/Power menu (page 31).
- 3** Start a web browser on the computer, enter the following in the address field, then press the Enter key on your computer.
`http://xxx.xxx.xxx.xxx`
(xxx.xxx.xxx.xxx: IP address for the projector)
You can confirm the IP address of the projector in the “LAN Settings” on the Connection/Power menu (page 31).

The following window appears in the Web browser:

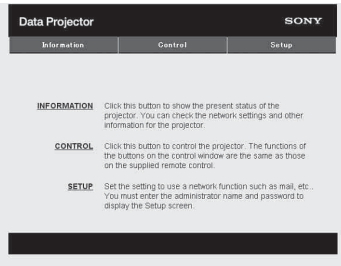

Once you make the network settings, you can open the Control window only by performing step 3 of this procedure.

How to operate the Control window

Switching the page

Click one of the Page Switching buttons to display the desired setting page.

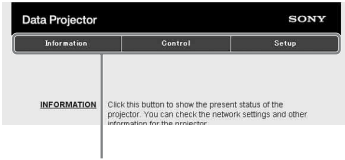

Page Switching buttons

Setting the access limitation

You can limit a user for accessing any particular page.

Administrator: Allowed access to all pages

User: Allowed access to all pages except the Setup page

Set the access limitation from [Password] of the Setup page.

When you access the Setup page for the first time, enter “root” in the user name box in the authentication dialogue and enter “Projector” in the password box. The Name box of the Administrator is preset to “root.”

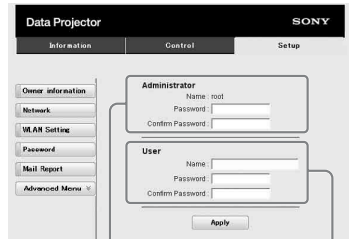

Entry area for [Administrator]

Entry area for [User]

When you change the password, input a new password after deleting the password (*****) that was set.

The password of the administrator and user can be set using up to 16 characters for each.

Note

If you forget your password, consult with qualified Sony personnel.

Confirming the Information regarding the Projector

You can confirm the current settings for the projector on the Information page.

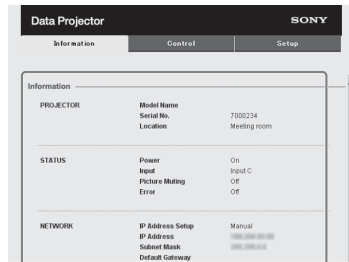

Information area

Operating the Projector from a Computer

You can control the projector from the computer on the Control page.

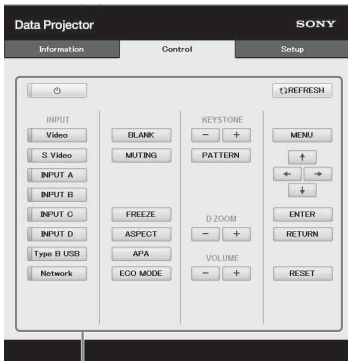

Operation area

The functions of the buttons shown in the operation area are the same as the keys on the remote commander.

Using the e-mail report Function

Set the e-mail report function on the Setup page.

Entered values will not be applied unless you click on [Apply].

- 1 Click on [Owner information] to enter the owner information recorded in the e-mail report.

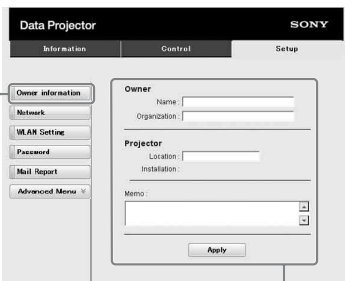

Owner information button

1

- 2 Set the timing of the e-mail report. Click on [Mail Report] to open the Mail Report page.

Lamp Reminder (Lamp1): Set the timing of the email report for lamp replacement. To reset Lamp Reminder, execute "Lamp Timer Reset" on the projector (page 29).

Maintenance Reminder: Set the timing of the email report for maintenance. To reset Maintenance Reminder, check the RESET check box and then click on [Apply].

Mail Report button

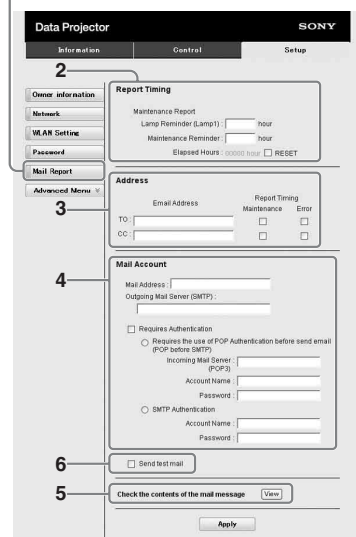

- 3 Enter the outgoing e-mail address in the Email Address box then check the Report Timing check box of the e-mail report to be sent.

- 4 Set the mail account for sending e-mail reports.

Mail Address: Enter the e-mail address.
Outgoing Mail Server (SMTP): Enter the address of outgoing mail server (SMTP).

Required Authentication: Check this check box if authentication is required for sending e-mail.

Requires the use of POP

Authentication before sending email (POP before SMTP): Check this check box to arrange for POP authentication to be performed before sending e-mail.

Incoming Mail Server (POP3): Enter the address of the incoming-mail server (POP3) to be used for POP authentication.

Account Name: Enter the mail account name.

Password: Enter the password.

SMTP Authentication: Check this check box to arrange for SMTP authentication to be performed before sending e-mail.

Account Name: Enter the mail account name.

Password: Enter the password.

5 Confirm the contents of the e-mail report.
When you click on [View], the contents of the e-mail report are displayed.

6 Send the test mail.
Check on the Send test mail check box then click on [Apply] to send your test mail to the e-mail address you set.

Notes

- The email report function will not work if the network uses Outbound Port25 blocking, which prevents access to the SMTP server.
- You cannot use the following characters to enter the characters in the text box: “'”, ““”, “\”, “&”, “<”, “>”

Setting the LAN Network of the projector

Set the LAN network function on the Setup page.

Entered values will not be applied unless you click on [Apply].

1 Click on [Network] to open the Network page.

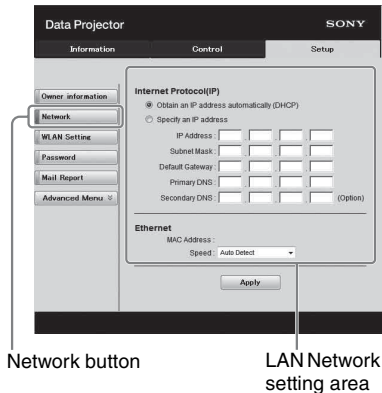

2 Set the items for internet protocol.

Obtain an IP address automatically:

Automatically provides the network settings by a DHCP server function, such as the router. The IP Address, Subnet Mask, Default Gateway, Primary DNS, and Secondary DNS display the values provided by a DHCP server.

Specify an IP address: Set the network manually.

-IP Address: Input the IP address of the projector.

-Subnet Mask: Input the subnet mask of the projector.

-Default Gateway: Input the default gateway of the projector.

-Primary DNS: Input the primary DNS server of the projector.

-Secondary DNS: Input the secondary DNS server of the projector.

3 Set the items for Ethernet.

MAC Address: Displays the MAC address of the projector.

Setting the WLAN Network of the projector

Set the WLAN network function on the Setup page.

Entered values will not be applied unless you click on [Apply].

To use the wireless LAN network, a USB wireless LAN module IFU-WLM3 (not supplied) is necessary.

- 1 Click the [WLAN Setting] to open the WLAN Setting page.

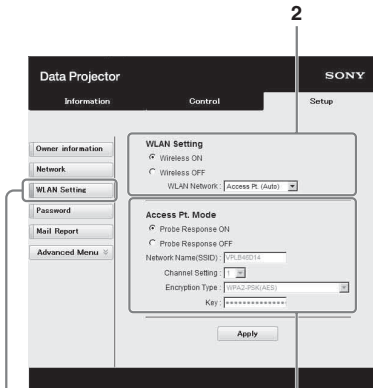

WLAN Setting button

3-(a)

- 2 Enable or disable the radio wave output of USB wireless LAN module.

Wireless ON: Enables radio wave output of USB wireless LAN module.

Wireless OFF: Disables radio wave output of USB wireless LAN module.

WLAN Network: Set the modes for USB wireless LAN module.

| Items | Descriptions |
|---------------------|---|
| Access Pt. (Auto) | Activates USB wireless LAN module as an access point, and items for WLAN are automatically set. |
| Access Pt. (Manual) | Activates USB wireless LAN module as an access point. Set the items for WLAN manually. |
| Client | Activates USB wireless LAN module as a client. |

- 3 (a) Input the settings for Access Pt. Mode.

When the USB wireless LAN module is activated as an access point, set the items for the access point.

Probe Response ON: Responds to the probe request from the client.

Probe Response OFF: Does not respond to the probe request from the client.

Network Name (SSID): Displays the SSID of the access point if “WLAN Network” is set to “Access Pt. (Auto).” Input the SSID of the access point if “Access Pt. (Manual)” is selected.

Channel Setting: Displays the channel of the access point if “WLAN Network” is set to “Access Pt. (Auto).” Select the channel of the access point if “Access Pt. (Manual)” is selected.

Encryption Type: Displays the security method of the access point if “WLAN Network” is set to “Access Pt. (Auto).” Select the security method of the access point from the following list if “Access Pt. (Manual)” is selected.

| Encryption Type | Descriptions |
|-----------------------------------|--|
| Open | Sets the security method of the access point to open system authentication. |
| WEP 64bit | Sets the security method of the access point to WEP (64bit). |
| WEP 128bit | Sets the security method of the access point to WEP (128bit). |
| MIX (WPA-PSK/WPA2-PSK (TKIP/AES)) | Sets the security method of the access point to MIX. (corresponding to both WPA-PSK (TKIP/AES) and WPA2-PSK (AES) security methods). |
| WPA2-PSK(AES) | Sets the security method of the access point to WPA2-PSK (AES). |

Key: Input the password for security method of the access point according to the selected encryption type as below;

| Encryption Type | Password |
|---|---|
| Open | The password cannot be input. |
| WEP 64bit | Input 5 ASCII characters for a password. |
| WEP 128bit | Input 13 ASCII characters for a password. |
| MIX (WPA-PSK/WPA2-PSK (TKIP/AES)) or WPA2-PSK (AES) | Input 8-63 ASCII characters for a password. |

(b) Input the settings for Client Mode.

When the USB wireless LAN module is activated as a client, set the items for the client (set the items for the access point the projector tries to connect to).

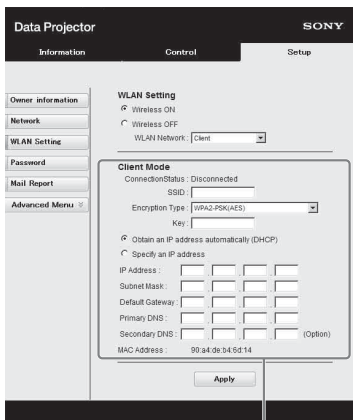

3-(b)

Connection Status: Displays the connecting status between the access point and projector.

ESSID: Input the ESSID of access point the projector tries to connect to.

Encryption Type: Select the security method of access point the projector tries to connect to from the following list.

| Encryption Type | Descriptions |
|-----------------------------------|--|
| Open | Sets the security method of the access point to open system authentication. |
| WEP 64bit | Sets the security method of the access point to WEP (64bit). |
| WEP 128bit | Sets the security method of the access point to WEP (128bit). |
| MIX (WPA-PSK/WPA2-PSK (TKIP/AES)) | Sets the security method of the access point to MIX. (corresponding to both WPA-PSK (TKIP/AES) and WPA2-PSK (AES) security methods). |
| WPA2-PSK (AES) | Sets the security method of the access point to WPA2-PSK (AES). |

Key: Input the password for security method of the access point according to the selected encryption type as below;

| Encryption Type | Password |
|---|---|
| Open | The password cannot be input. |
| WEP 64bit | Input 5 ASCII characters for a password. |
| WEP 128bit | Input 13 ASCII characters for a password. |
| MIX (WPA-PSK/WPA2-PSK (TKIP/AES)) or WPA2-PSK (AES) | Input 8-63 ASCII characters for a password. |

Obtain an IP address automatically:

Automatically provides the network settings by a DHCP server function, such as the router. The IP Address, Subnet Mask, Default Gateway, Primary DNS, and Secondary DNS display the values provided by a DHCP server.

Specify an IP address: Set the network manually.

-IP Address: Input the IP address of the projector.

- Subnet Mask:** Input the subnet mask of the projector.
- Default Gateway:** Input the default gateway of the projector.
- Primary DNS:** Input the primary DNS server of the projector.
- Secondary DNS:** Input the secondary DNS server of the projector.
- MAC Address:** Displays the MAC address for USB wireless LAN module.

Setting the Custom Labels for the Input Connectors of the Projector

Change the label names for the input connectors that will be displayed on the projected screen on the Setup page. The entered label names will not be applied unless you click on [Apply].

1 Click on [Advanced Menu] to open the Setup page.

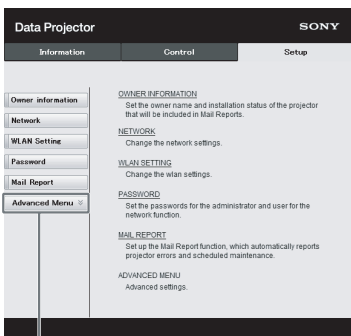

Advanced Menu button

2 Click on the [Input Label] and open the Input Label setting window.

Clear the check box for the label that you want to change and input the label name. You can input up to 20 of the following letters.

Alphabets: “a” to “z”, “A” to “Z”

Numbers: “0” to “9”

Characters: “.” “,” “:” “;” “.” “/” “\” “|” “_” “~” “@” “#” “\$” “%” “&” “(” “)” “<” “>” “[” “]” “{” “}” “|” “=” “;” “+” “-” “/” “_” “\” “^” “~” “~”

space

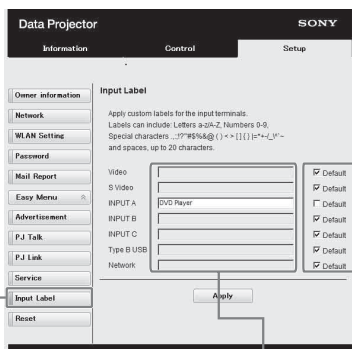

Input Label button

Label name for the input connector

Use the factory default setting

Network

3 Click the [Apply] button to apply the set label names.

The label name will be reflected on the screen when the input of the projector is changed.

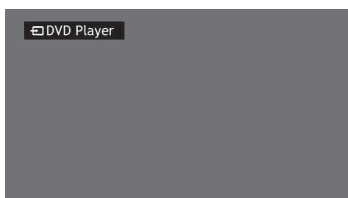

Input Connector Label Display Screen

Setting the Control Protocol of the Projector

Change the settings for the control protocol on the Setup page. Entered values will not be applied unless you click on [Apply].

- 1 Click on [Advanced Menu] to display the buttons for more settings.

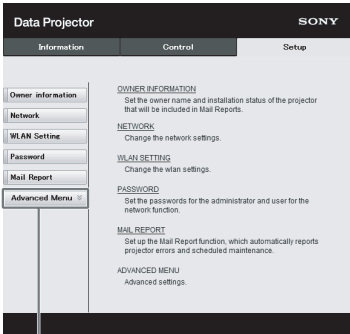

Advanced Menu button

- 2 (a)Set Advertisement.

Advertisement Service setting area

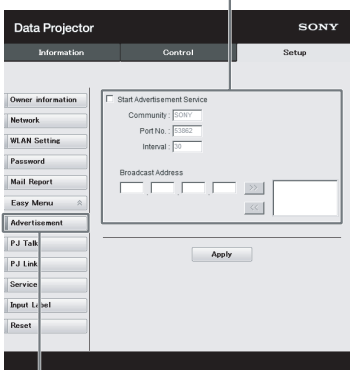

Advertisement button

Start Advertisement Service:

Set Advertisement to enabled or disabled. Items for Advertisement are enabled only when this function is enabled. The function is disabled at the factory default.

-Community:

Input the community name for Advertisement and PJ Talk. If the community name for Advertisement is changed, the one for PJ Talk will also be changed. Only four alphanumeric characters can be input. The factory default setting is "SONY." It is recommended that the community name be changed from the factory setting to avoid unnecessary access to the projector from other computers.

-Port No.:

Input the transmit port of Advertisement. The factory default setting is "5382."

-Interval:

Input the transmission interval (minutes) of Advertisement. The factory default setting is "30."

-Broadcast Address:

Input the destination of data via Advertisement. If nothing is input, the data will be broadcast in the same subnetwork.

- (b)Set PJ Talk.

PJ Talk Service setting area

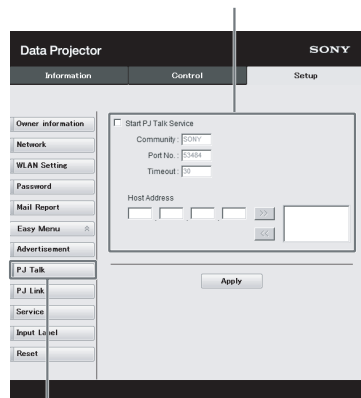

PJ Talk button

Start PJ Talk Service:

Set PJ Talk to enabled or disabled. Items for PJ Talk are enabled only when this function is enabled. The function is disabled at the factory default.

-Community:

Input the community name of Advertisement and PJ Talk. If the community name for PJ Talk is changed, the one for Advertisement will also be changed. Only four alphanumeric characters can be input. The factory default setting is “SONY.” It is recommended that the community name be changed from the factory setting to avoid unnecessary access to the projector from other computers.

-Port No.:

Input the server port of PJ Talk. The factory default setting is “53484.”

-Timeout:

Input the time (minutes) until PJ Talk communication is terminated in the case that it is disconnected. The factory default setting is “30.”

-Host Address:

Input the IP address that the PJ Talk server is allowed to receive. If no IP address is input, receiving commands will be allowed from any IP address. From the moment the IP address is input, access will be allowed only from that input IP address. For security reasons, it is recommended to input an IP address to restrict access.

(c)Set PJ Link.

PJ Link Service setting area

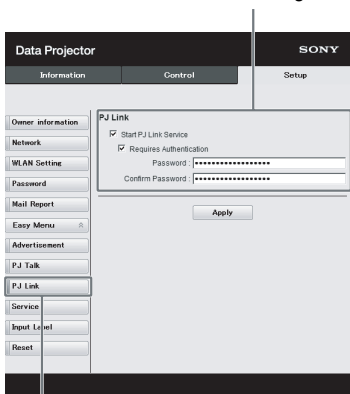

PJ Link button

Start PJ Link Service:

Set PJ Link to enabled or disabled. Items for PJ Link are enabled only when this function is enabled. This function is disabled at the factory setting.

-Requires Authentication:

Set the authentication for PJ Link to enabled or disabled.

-Password:

Input the authentication password for PJ Link. For the factory default password, refer to the PJ Link specifications.

(d)Set the system service.

System service setting area

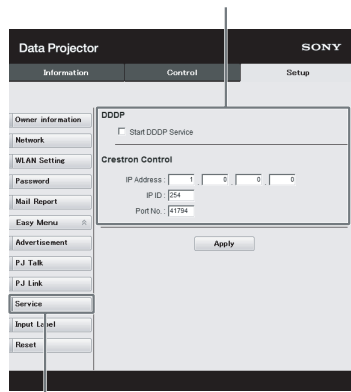

Service button

Start DDDP Service:

Set DDDP to enabled or disabled. For details, refer to the DDDP specifications in the reference from AMX Corporation. The function is disabled at the factory default.

Crestron Control:

For details, refer to the specifications in product catalogues, etc., from Crestron Corporation.

-IP Address:

Input the Crestron system server.

-IP ID:

Input the IP ID for the CIP protocol.

-Port No.:

Input the port number for the CIP protocol server.

(e)Reset the network settings.



Reset:
Reset all Web browser settings to their factory defaults.

Using Presentation Function via Network

The Presentation Function via Network enables you to do the following:

- Connect a maximum of eight computers to the projector.
- Project images from a maximum of four computers simultaneously.
- Connecting a USB wireless LAN module (not supplied) to the projector as an access point, allows the projector to connect to up to seven computers simultaneously.

Presentation Function via Network requires installation of Projector Station for Network Presentation (supplied CD-ROM). For information on updates of Projector Station for Network Presentation, visit Sony's web site: <https://www.servicesplus.sel.sony.com/>
System requirements for using the application are as follows.

OS

Windows XP: Home/Professional

Windows Vista: Home Premium/Business/Ultimate/Enterprise

Windows 7: Home Premium/Professional (Recommended)/Ultimate/Enterprise

Windows 8/8.1

Mac OS X: 10.6.x/10.7.x/10.8.x/10.9.x

CPU

Pentium4 2.8GHz or faster

Notes

- To install the application, administrative rights are required.
- If you do not have administrative rights, the application may not run properly.
- If firewall or security software is installed, the application may not run properly.
- Depending on the type of network adapter, the application may not run properly.
- Movie player (Media Player, etc.) images may not be projected properly.

Installing Projector Station for Network Presentation

- 1 Close all running applications.
- 2 Insert the supplied CD-ROM into the CD-ROM drive of the computer.
- 3 Open the CD-ROM.
For Windows:
Double-click the .exe file. When the message "User Account Control" is displayed, click "Allow" or "Yes."
For Mac:
Double-click the .pkg file.
- 4 Follow the on-screen instructions to install the software.

Starting Projector Station for Network Presentation

- 1 Connect the projector to a network.
For a wired connection, connect the projector by a LAN cable, then make the network settings. For details, see "LAN Settings" (page 31) or "Setting the LAN Network of the projector" (page 40).
For a wireless connection, see "LAN connector" (page 10) or "USB connector (Type A) (↔)" (page 11). Also check "WLAN Settings" (page 31).
- 2 Turn on the projector.
Select "Network" as the input source (page 17).

3 Start Projector Station for Network Presentation.

For Windows:

Select [Start]-[All Programs]-[Projector Station for Network Presentation] on the computer.

For Mac:

Double-click [Projector Station for Network Presentation] in Applications folder.

Projecting an Image

After starting Projector Station for Network Presentation, the connection method selection window appears.

1 Select the connection method.

Select “Network connection” or “Wireless direct connection” depending on your use environment.

Network connection: Select this item when the projector uses LAN or “WLAN Network” is set to “Client” on the Connection/Power menu.

Wireless direct connection: Select this item when “WLAN Network” is set to “Access Pt. (Auto)” or “Access Pt. (Manual)” on the Connection/Power menu of the projector.

For Windows:

Connection method selection window

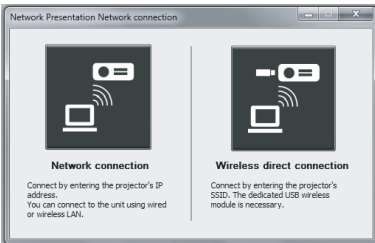

Network connection window

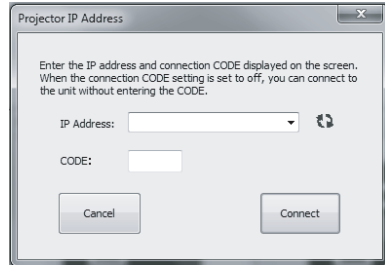

Wireless direct connection window



Notes

- The appearance of the application on the screen is subject to change without notice.
- When a projector is connected to a network via a wireless connection, if the “SSID” is changed from the factory default, it may not be found.
- When a projector is connected to a network via a wired connection, depending on the network environment, it may not be found.

2 Set the projector an image will be projected to.

a) Network connection

Select or directory input the IP address of the projector that the computer is connected to. If the Connection CODE function is activated, input the four digit Connection CODE that is displayed on the right bottom area of the screen.

b) Wireless direct connection

Select or directory input the SSID of the projector that the computer is connected to. If the “WLAN settings” is set to “Access Pt.(Auto)” and “Auto” has been checked, you can skip inputting the wireless password.

3 Click “Connect”.

If other users are projecting an image, the controller appears on the screen. Click the  to start projecting an image (page 49).

If no users are projecting an image, the controller appears on the screen and starts projecting an image.

Note

Display related settings (such as your computer’s resolution) change when the application is started.

Connection Settings

| Item | Item descriptions |
|---|---|
| IP Address | Input the IP Address. List the IP addresses of the projectors on the network and IP addresses of projectors connected so far, as candidates. |
| SSID | Input SSID. List the peripheral SSIDs and SSIDs of projectors connected to the computer so far, as candidates. |
|  Update button | Search the network again and update the candidate list of the projectors. |
| Security Method | Displays the security method of the input SSID. |
| Wireless Password | Input the wireless password of the SSID. If open system Authentication is used, input of the wireless password is unnecessary. |
| Auto (checkbox) | Check this item when the “WLAN settings” is set to “Access Pt.(Auto)”. |
| CODE | Input the Connection CODE displayed on the screen of the projector. |

| Item | Item descriptions |
|---------|--|
| Connect | Connect to the projector that is set in the items above and start to project an image. |





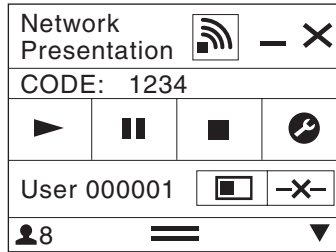

Using the Controller

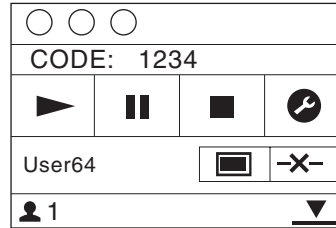









For Windows:



For Mac:



| Items | Functions |
|---|--|
|  | Start projecting an image. |
|  | Pause projecting an image. |
|  | Stop projecting an image (screen turns black). |
|  | Change the application settings. |
|  | Disconnect from the projector. |
|  | Select a projection method then start projecting an image. |

| Items | Functions | |
|---|---|--|
| Projection method |  | Not projecting an image. |
| |  | Project in full screen. |
| |  | Project in the left half of the screen. |
| |  | Project in the right half of the screen. |
| |  | Project in the upper left quadrant of the screen. |
| |  | Project in the upper right quadrant of the screen. |
| |  | Project in the lower left quadrant of the screen. |
| |  | Project in the lower right quadrant of the screen. |
|  | Display the strength of the wireless signal. | |
| CODE | Display the Connection CODE of the projector that is connected to the computer. | |
|  | Display the number of users connected to the projector. | |
|  | Display the users' status. | |

*2: Depending on your Internet connection, a data communication fee may apply.

Displaying Images or Files Sent from a Tablet PC/ Smartphone

You can project JPEG images, PDF files, etc. stored in a tablet PC/smartphone wirelessly by using a specific application. *1

For downloading *2 or detailed method of using the application, access the following URL.

<http://PWPresenter.pixelworks.com>



*1: To use the application, one of the following conditions is required.

- Connected to network where wireless connection can be established (page 10).
- Connected to a wireless network via USB wireless LAN module IFU-WLM3 (not supplied) that is connected to the projector (page 11).

Playing Video and Audio using USB Connection

You can also play video and audio simply by connecting the projector and computer with a USB A-B cable (not supplied).

Playing video and audio using USB connection requires to start USB Display. System requirements for using the application are as follows.

OS

Windows XP: Home/Professional

Windows Vista: Home Premium/Business/Ultimate/Enterprise

Windows 7: Home Premium/Professional (Recommended)/Ultimate/Enterprise

Windows 8/8.1

Mac OS X: 10.6.x/10.7.x/10.8.x/10.9.x

CPU

Pentium4 2.8GHz or faster

Starting USB Display

- 1 Connecting the projector and your computer with a USB A-B cable (not supplied) (page 10).
- 2 Turn on the projector.
Select “Type B USB” as the input source (page 17). After a short time, the projector is recognized as a CD-ROM drive in the computer.
- 3 Open “USB Display” in the CD-ROM drive.

Notes

- The resolution of your computer changes when the application is started.
- Depending of the computer’s setting, the application may start automatically.
- When you are finished using the projector, you can simply disconnect the USB cable without using the Safely Remove Hardware option.
- Movie player (Media Player, etc.) images may not be projected properly.

Playing Video and Audio

After starting USB Display, the controller appears on the screen, and projection playback starts automatically.





Using the Controller

For Windows:

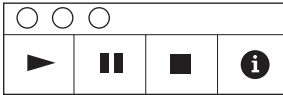

For Mac:



| Items | Functions |
|---|---|
|  | Start audio/video playback. |
|  | Pause audio/video playback. |
|  | Stop audio/video playback (the screen turns black). |
|  | Display information about USB Display. |

Indicators

The indicators allow checking the status and notify you of abnormal operation of the projector. If the projector exhibits abnormal status, address the problem in accordance with the table below.

ON/STANDBY indicator

| Status | Meaning/Remedies |
|-------------------------|--|
| Lights in red | The projector is in Standby mode. |
| Flashes in green | <ul style="list-style-type: none"> • The projector is ready to operate after having been turned on. • The lamp cools after the projector is turned off. |
| Lights in green | The projector's power is on. |
| Lights in orange | The projector is in With No Input (Lamp Cutoff) or when the Speaker Setting is set to "Always On." |
| Flashes in red | The projector is in abnormal status. Symptoms are indicated by number of flashes. Address the problem in accordance with the following. If the symptom is shown again, consult with qualified Sony personnel. |
| Flashes twice | <p>The internal temperature is unusually high. Check the items below.</p> <ul style="list-style-type: none"> • Check if nothing is blocking the ventilation holes. (pages 4, 4) • Check if the air filter is not clogged. (page 60) • Check if the Installation Attitude in the Installation menu is set correctly. (page 34) |
| Flashes six times | Unplug the AC power cord from a wall outlet. After checking that the ON/STANDBY indicator goes out, plug the power cord to a wall outlet again then turn on the projector. |
| Other number of flashes | Consult with qualified Sony personnel. |

LAMP/COVER indicator

| Status | Meaning/Remedies |
|---------------------|--|
| Flashes in red | Symptoms are indicated by number of flashes. Address the problem in accordance with the following. |
| Flashes twice | The lamp cover is not attached securely. (page 58) |
| Flashes three times | <p>The temperature of the lamp is unusually high. Turn off the projector and turn it on again after the lamp has cooled. If the same symptom occurs, turn off the projector again and remove the lamp (page 58), then check if the lamp is not broken.</p> <p>If the lamp is not broken, reattach the lamp and turn on the projector again.</p> <p>If the symptom occurs again, the lamp may be exhausted. In this case, replace the lamp with a new one (page 58).</p> <p>If the lamp is broken, do not exchange the lamp by yourself. Consult a qualified Sony consultant.</p> |

Messages List

When any of the messages listed below appears on the projected image, address the problem in accordance with the table below.

| Messages | Meaning/Remedy | Page |
|---|--|-----------|
| High temp.! Lamp off in 1 min. | Check the items below. <ul style="list-style-type: none"> • Check if nothing is blocking the ventilation holes. • Check if the air filter is not clogged. • Check if the Installation Attitude in the Installation menu is set correctly. | 4, 34, 60 |
| Frequency is out of range! | Change the output setting of the connected equipment to one for signals supported by the projector. | 66 |
| Please check Input-A Signal Sel. | Set “Input-A Signal Sel.” to “Auto” or select the input signal type to suit to the input signal. | 31 |
| Please clean the filter. | Clean the air filter. | 60 |
| Please replace the Lamp and clean the Filter. | Replace the lamp with a new one and clean the air filter. The message appears whenever you turn on the power until you replace the lamp and reset the lamp timer. | 58, 60 |
| Projector temperature is high. High Altitude Mode should be “On” if Projector is being used at high altitude. | When not using the projector at an altitude of 1,500 m or higher, check the items below. <ul style="list-style-type: none"> • Check if nothing is blocking the ventilation holes. • Check if the air filter is not clogged. • Check if Installation Attitude in the Installation menu is set correctly. | 4, 34, 60 |
| Not applicable! | Invalid key was pressed. | – |
| The control keys are locked! | “Control Key Lock” is set to “On.” | 30 |
| Projector lamp will cut off soon. Press I/⏻ key to restart. | The I/⏻ key was pressed and the projector lamp will be cut off soon. To cancel lamp cut off, press the I/⏻ key again (the projector will return to the on status). To cut off the lamp immediately, press and hold the I/⏻ key for several seconds. | 23 |
| Lamp Dimming | Reduces lamp output when “With Static Signal” is set. When any change in signal is detected, or an operation (remote control or control panel) is performed, normal brightness is restored. | 32 |
| Unsupported USB device. | Connect the designated USB device (USB wireless LAN module IFU-WLM3 (not supplied)). | 11 |
| Unsupported USB hub. | The projector does not support USB hubs. Connect the designated USB device (USB wireless LAN module IFU-WLM3 (not supplied)). | 11 |
| Please check HDBaseT Settings. * VPL-CH375/CH355 only | Set “HDBaseT/LAN connector” depending on the HDBaseT/LAN connection. | 31 |

Troubleshooting

Before asking to have the projector repaired, try to diagnose the problem, following the instructions below.

| Symptoms | Remedy | Page |
|--|--|-----------|
| The power is not turned on. | Check if the AC power cord is firmly connected. | – |
| | When the “Control Key Lock” is set to “On,” you cannot turn on the projector using the I/Ⓞ key on the projector. | 30 |
| | If the lamp or lamp cover is not attached securely, the projector cannot be turned on. | 58 |
| No image. | Check if the connecting cable is connected to external equipment firmly. | 9 |
| | Check the computer signal is set for output to an external monitor only. If you set your computer to output to both the computer’s display and an external monitor, the external monitor image may not be displayed properly. Set your computer to output to only an external monitor. | 17 |
| | Check if the application “USB Display” or “Projector Station for Network Presentation” is running. | 47, 51 |
| | Check if the input source is correctly selected. | 17 |
| | Check if the picture is muted by pressing the BLANK key. | 7 |
| The application “USB Display” or “Projector Station for Network Presentation” does not start. | Check if the computer connected to the projector meets the system requirement for the applications. | 47, 51 |
| The computer cannot connect to the projector. | <ul style="list-style-type: none"> • Check “LAN Settings” of the projector. • Check the condition of the wireless connection. | 31 |
| On-screen display does not appear. | The on-screen display does not appear when “Status” in the Operation menu is set to “Off.” | 30 |
| The aspect ratio of the display is not right/the image is displayed smaller /a portion of image does not appear. | The image may not display correctly because the input signal cannot be judged correctly. In this case, set “Aspect” manually. | 7, 26, 28 |
| The image is a trapezoid. | The images become trapezoidal because of the projection angle. In this case, you can correct the trapezoidal distortion, using a Keystone feature. | 7, 20, 34 |
| | When the “V Keystone” is set to “Manual,” the keystone feature does not work automatically. Set “V Keystone” to “Auto” or “Manual” to set manually. | 7, 20, 34 |
| | When the projector is installed on an uneven surface, the feature may not work properly. In this case, select “Manual” to set “V Keystone” manually. | 7, 20, 34 |

Others

| Symptoms | Remedy | Page |
|---|--|--------|
| The image is dark/too bright. | The settings for “Brightness,” “Contrast,” and “Lamp Mode” affect brightness of the image. Check if the value is appropriate. | 25, 31 |
| | The image will be dark when the lamp is burnt out. Check “Lamp Timer,” and replace the lamp with a new one if necessary. | 36, 58 |
| | “With Static Signal” is set to “On.” | 32 |
| | During picture muting, the lamp is dimmed to reduce power consumption. | 32 |
| | When video signal is not input, the lamp is dimmed to reduce power consumption. | – |
| The image becomes darker or brighter. | When the lamp is dimmed for a long time, brightness may increase temporarily, but this is not malfunction. | – |
| | When the “Lamp Mode” is set to “Auto,” the luminance of the lamp changes according to the input image. | 31 |
| The image is not clear. | Check if the projector is in focus. | 18 |
| | The picture will not be clear if condensation has accumulated on the lens. In this case, let the projector sit for about two hours with the power on. | – |
| The image is noisy. | Check if the connecting cable is connected to the external equipment properly. | 9 |
| No sound. | Check that the connecting cables between the projector and external video or audio equipment are securely connected. | 9 |
| | Check if the external audio equipment is set properly. | – |
| | Audio is not output if “Speaker” is set to “Off.” | 29 |
| | Audio is not output if audio muting is activated. | 7 |
| | Check if the volume is not set to minimum. | 7, 29 |
| The remote commander does not work. | Check if the batteries are installed correctly. | – |
| | Check if the batteries are not exhausted. | – |
| The fan is noisy. | The sound from the fan is often greater than normal to cool the lamp, etc. in the following cases. <ul style="list-style-type: none"> • “Lamp Mode” is set to “High.” • The unit is used at a high altitude. “High Altitude Mode” is set to “On.” • The unit is used in the location where the temperature is high. | 31, 34 |
| | If the ventilation holes are blocked, the internal temperature of the projector rises and the fan noise becomes larger. | 4 |
| The image is distorted by the HDBaseT connection. | Confirm whether the unit’s AC power cord is grounded. Use the STP (Shielded Twisted Pair) type LAN cable. | – |

| Symptoms | Remedy | Page |
|---|---|------|
| The image is not projected properly when the projector is connected via the HDBaseT connector and the cables are inserted or removed from other connectors. | Change the input connector to project the image properly. | - |

Replacing the Lamp

Replace the lamp with a new one if a message displayed on the projected image (pages 53, 54). Use an LMP-C281/C250 projector lamp (not supplied) for replacement.

Caution

- The lamp remains hot after the projector is turned off. **If you touch the lamp, you may burn your finger. When you replace the lamp, wait for at least an hour after turning off the projector for the lamp to cool sufficiently.**
- Do not allow any metallic or inflammable objects into the lamp replacement slot after removing the lamp, otherwise it may cause electrical shock or fire. Do not put your hands into the slot.

Notes

- **If the lamp breaks, contact qualified Sony personnel. Do not replace the lamp yourself.**
- When removing the lamp, be sure to pull it out straight, by holding the designated location. If you touch a part of the lamp other than the designated location, you may be burned or injured. If you pull out the lamp while the projector is tilted, the pieces may scatter if the lamp breaks any may cause injury.

- 1 Turn off the projector, and disconnect the AC power cord from a wall outlet.
- 2 When the lamp has cooled sufficiently, open the lamp cover by loosening 3 screws.

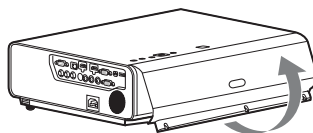
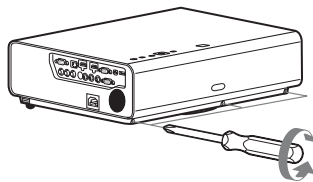

You can remove the lamp cover for a while when installing on the ceiling. Take care to prevent the lamp cover from falling down, as it is not fixed. Do not apply pressure to the lamp cover while it is open.

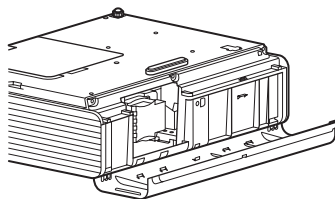

- 3 Loosen the 3 screws on the lamp (1) then pull out the lamp by its grab (2).

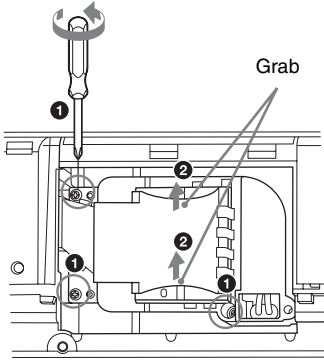

- 4 Insert the new lamp all the way in until it is securely in place (1). Tighten the 3 screws (2).

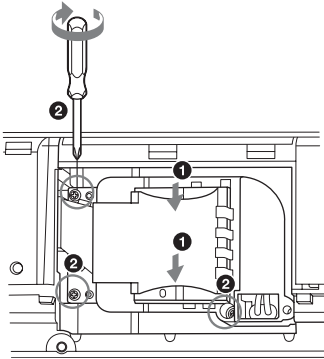

- 5 Close the lamp cover and tighten the 3 screws.

Note

Be sure to install the lamp and Lamp cover securely as it was. If not, the projector cannot be turned on.

- 6 Connect the AC power cord to a wall outlet and turn on the projector.

- 7 Reset the lamp timer for notification of the next replacement time.

Select “Lamp Timer Reset” on the SET SETTING menu then press the ENTER key. When a message appears, select “Yes” to reset the lamp timer (page 29).

Caution

Disposal of the used lamp

For the customers in the USA

Lamp in this product contains mercury. Disposal of these materials may be regulated due to environmental considerations. For disposal or recycling information, please contact your local authorities or the Telecommunications Industry Association (www.eiae.org).

Cleaning the Air Filter

When a message appears on the projected image, clean the air filter (page 54). If the dust cannot be removed from the air filter even after cleaning, replace the air filter with a new one. For details on a new air filter, consult with qualified Sony personnel.

Caution

If you neglect to clean the air filter, dust may accumulate, clogging it. As a result, the temperature may rise inside the unit, leading to a possible malfunction or fire.

- 1 Turn off the projector, and disconnect the AC power cord from the AC outlet.
- 2 Draw out the air filter cover.

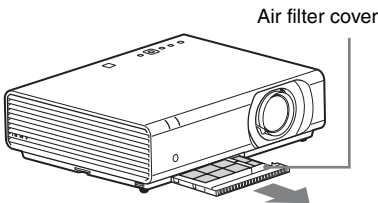

Note

If you remove the air filter cover when power is turned on and the AC power cord is not removed from the AC outlet, avoid touching the fan inside the unit, as it may cause injury.

- 3 Clean the air filter with a vacuum cleaner.
Remove the filter holder to remove the air filter.

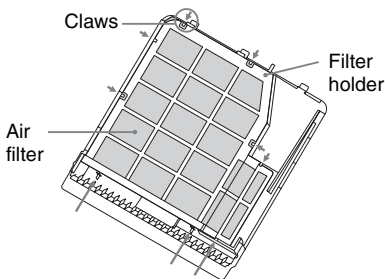

The air filter consists of 2 filters.

Upper filter: Black

Lower filter: Gray



- 4 Attach the air filter cover to the unit.

Note

Be sure to attach the air filter cover firmly. Incorrect attachment of the cover may cause a malfunction.

Specifications

| Items | | Descriptions |
|----------------------------------|---------------------------------|--|
| Model | | VPL-CH375/CH370/CH355/CH350 |
| Projection system | | 3 LCD system |
| Display device | Effective display size | 0.64-inch (16.3 mm), 3 plate, Aspect ratio 16:10 |
| | Effective picture elements | 6,912,000 pixels (1920 × 1200 pixels, 3 plate panels) |
| Projection lens | Focus | Manual |
| | Zoom | Manual |
| Light source | | VPL-CH375/CH370: 280 W VPL-CH355/CH350: 250 W |
| Projected image size | | 40 inches to 300 inches (1.02 m to 7.62 m) |
| Luminous flux (Brightness) | | VPL-CH375/CH370: 5000 lm VPL-CH355/CH350: 4000 lm (when “Lamp Mode” is set to “High”) |
| Speaker | | 12 W × 1 (monaural) |
| Applicable scanning frequency *1 | | Horizontal: 19 kHz to 92 kHz, Vertical: 48 Hz to 92 Hz |
| Resolution | When a computer signal is input | Maximum display resolution: 1920 × 1200 pixels Panel display resolution: 1920 × 1200 pixels |
| | When a video signal is input | NTSC, PAL, SECAM, 480/60i, 576/50i, 480/60p, 576/50p, 720/60p, 720/50p, 1080/60i, 1080/50i, 1080/24p |
| Color system | | NTSC ^{3.58} , PAL, SECAM, NTSC ^{4.43} , PAL-M, PAL-N, PAL60 |

Others

| Items | Descriptions |
|----------------------------------|---|
| Model | VPL-CH375/CH370/CH355/CH350 |
| INPUT OUTPUT (Computer/video) | <p>INPUT A</p> <p>RGB/YPbPr input connector: Mini D-sub 15 pin female, G with sync/Y: 1 Vp-p \pm 2 dB, sync negative, 75 ohms terminated, RGB/PbPr: 0.7 Vp-p \pm 2 dB, 75 ohms terminated, Sync signal: TTL level high impedance, positive/negative</p> <p>Audio input connector: Stereo mini jack, rated input 500 mVrms, input impedance more than 47 kohms</p> <hr/> <p>INPUT B/ INPUT C</p> <p>HDMI input connector: HDMI 19-pin, HDCP support,</p> <p>Audio input connector: HDMI audio support</p> <hr/> <p>S VIDEO IN</p> <p>S video input connector: Mini DIN 4-pin, Y: 1 Vp-p \pm 2 dB, sync negative, 75 ohms terminated, C: (burst signal) 0.286 (NTSC)/0.3 (PAL/SECAM) Vp-p \pm 2 dB, 75 ohms terminated</p> <p>Audio input connector: Phono jack \times 2, rated input 500 mVrms, Input impedance more than 47 kohms</p> <hr/> <p>VIDEO IN</p> <p>Video input connector: Phono jack, 1 Vp-p \pm 2 dB, sync negative, 75 ohms terminated</p> <p>Audio input connector: Shared with S VIDEO IN</p> <hr/> <p>OUTPUT</p> <p>MONITOR output connector: Mini D-sub 15-pin female, G with sync/Y: 1 Vp-p \pm 2 dB, sync negative, 75 ohms terminated, RGB/PbPr: 0.7 Vp-p \pm 2 dB, 75 ohms terminated, Sync signal: HD, VD 4 V (open), 1 Vp-p (75 ohms), positive/negative</p> <p>Audio output connector: Stereo mini jack, stereo, 1 Vrms (maximum volume, when inputting 500 mVrms), output impedance 5 kohms</p> <hr/> <p>Others connector</p> <p>RS-232C connector: D-Sub 9 pin female</p> <hr/> <p>INPUT D</p> <p>HDBaseTTM4/LAN connector: RJ45, HDBaseT/100BASE-TX</p> <p>HDBaseT transmittable signal: HDMI (Video, Audio), RS-232C, Ethernet</p> <p>HDBaseT LAN cable: STP type (CAT5e or higher, straight, not supplied), Maximum length: 100 m</p> <hr/> <p>Operating temperature/ Operating humidity</p> <p>0 °C to 40 °C (32 °F to 104 °F)/20% to 80% (no condensation)</p> <hr/> <p>Storage temperature/ Storage humidity</p> <p>-10 °C to +60 °C (14 °F to 140 °F)/20% to 80% (no condensation)</p> <hr/> <p>Power requirements</p> <p>VPL-CH350/CH355: 100 V to 240 V AC, 3.6 A-1.6 A, 50/60 Hz</p> <p>VPL-CH370/CH375: 100 V to 240 V AC, 3.9 A-1.7 A, 50/60 Hz</p> <hr/> <p>Power consumption</p> <p>VPL-CH350/CH355: 100 V AC: 353 W 220 V AC: 334 W</p> <p>VPL-CH370/CH375: 100 V AC: 388 W 220 V AC: 367 W</p> |

| Items | Descriptions |
|-----------------------------|--|
| Model | VPL-CH375/CH370/CH355/CH350 |
| Standby power | VPL-CH370: 100 V AC: 4.7 W/0.3 W 240 V AC: 4.9 W/0.5 W VPL-CH375: 100 V AC: 6.1 W/0.3 W 240 V AC: 6.2 W/0.5 W VPL-CH350: 100 V AC: 4.7 W/0.5 W 240 V AC: 4.9 W/0.5 W VPL-CH355: 100 V AC: 6.1 W/0.5 W 240 V AC: 6.2 W/0.5 W |
| Heat dissipation | VPL-CH350/CH355: 100 V AC: 1,204 BTU/h 220 V AC: 1,139 BTU/h VPL-CH370/CH375: 100 V AC: 1,323 BTU/h 220 V AC: 1,252 BTU/h |
| Standard dimensions (W/H/D) | Approx. 406 × 122.3 × 330.5 mm (15 ³¹ / ₃₂ × 4 ¹³ / ₁₆ × 13 inches) Approx. 406 × 113 × 330.5 mm (15 ³¹ / ₃₂ × 4 ⁷ / ₁₆ × 13 inches) (without projecting parts) |
| Mass | Approx. 5.7 kg (12 lb 5 1/2 oz) |
| Supplied accessories | See “Checking the Supplied Accessories” in the supplied Quick Reference Manual. |
| Optional accessories *2 *3 | Projector Lamp LMP-C250 (for replacement) Projector Lamp LMP-C281 (for replacement) |

Notes

- *1: For details, refer to “Acceptable Input Signals” on page 66.
- *2: Information on accessories in this manual is current as of Aug. 2014.
- *3: Not all optional accessories are available in all countries and area. Please check with your local Sony Authorized Dealer.
- *4: VPL-CH375/CH355 only

Design and specifications of the unit, including the optional accessories, are subject to change without notice.

Pin assignment

HDMI connector (HDMI, female)

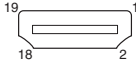

| | | | |
|----|-----------------------|----|-----------------------|
| 1 | T.M.D.S. Data2+ | 11 | T.M.D.S. Clock Shield |
| 2 | T.M.D.S. Data2 Shield | 12 | T.M.D.S. Clock - |
| 3 | T.M.D.S. Data2 - | 13 | N.C. |
| 4 | T.M.D.S. Data1+ | 14 | RESERVED (N.C.) |
| 5 | T.M.D.S. Data1 Shield | 15 | SCL |
| 6 | T.M.D.S. Data1 - | 16 | SDA |
| 7 | T.M.D.S. Data0+ | 17 | DDC GND |
| 8 | T.M.D.S. Data0 Shield | 18 | +5V Power |
| 9 | T.M.D.S. Data0 - | 19 | Hot Plug Detect |
| 10 | T.M.D.S. Clock+ | | |

RGB input connector (Mini D-sub 15-pin, female)

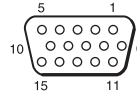

| | | | |
|---|-----------------------|----|----------------------------|
| 1 | Video input (red) R | 9 | Power supply input for DDC |
| 2 | Video input (green) G | 10 | GND |
| 3 | Video input (blue) B | 11 | GND |
| 4 | GND | 12 | DDC/SDA |
| 5 | RESERVE | 13 | Horizontal sync signal |
| 6 | GND (R) | 14 | Vertical sync signal |
| 7 | GND (G) | 15 | DDC/SCL |
| 8 | GND (B) | | |

RS-232C connector (D-Sub 9-pin, male)

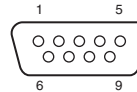

| | | | |
|---|------|---|-----|
| 1 | NC | 6 | NC |
| 2 | RXDA | 7 | RTS |
| 3 | TXDA | 8 | CTS |
| 4 | DTR | 9 | NC |
| 5 | GND | | |

USB connector (Type A, female)



| | |
|---|---------------------------------|
| 1 | V _{BUS} (4.4 - 5.25 V) |
| 2 | Data- |
| 3 | Data+ |
| 4 | Ground |

USB connector (Type B, female)



| | |
|---|------------|
| 1 | VCC (+5 V) |
| 2 | Data- |
| 3 | Data+ |
| 4 | Ground |

Acceptable Input Signals^{*1}

Computer signal

| Resolution | fH[kHz]/ fV[Hz] | Input connector | |
|-------------|--------------------|-----------------|-----------------|
| | | RGB/ YPbPr | HDMI |
| 640 × 350 | 31.5/70 | ● | |
| | 37.9/85 | ● | |
| 640 × 400 | 31.5/70 | ● | |
| | 37.9/85 | ● | |
| 640 × 480 | 31.5/60 | ● | ● |
| | 35.0/67 | ● | |
| | 37.9/73 | ● | |
| | 37.5/75 | ● | |
| 800 × 600 | 43.3/85 | ● | |
| | 35.2/56 | ● | |
| | 37.9/60 | ● | ● |
| | 48.1/72 | ● | |
| 832 × 624 | 46.9/75 | ● | |
| | 53.7/85 | ● | |
| | 49.7/75 | ● | |
| | 1024 × 768 | 48.4/60 | ● |
| 1024 × 768 | 56.5/70 | ● | |
| | 60.0/75 | ● | |
| | 68.7/85 | ● | |
| | 1152 × 864 | 64.0/70 | ● |
| 1152 × 864 | 67.5/75 | ● | |
| | 77.5/85 | ● | |
| | 1152 × 900 | 61.8/66 | ● |
| 1280 × 960 | 60.0/60 | | ● |
| 1280 × 1024 | 64.0/60 | ● | ● |
| | 80.0/75 | ● | |
| | 91.1/85 | ● | |
| 1400 × 1050 | 65.3/60 | | ● |
| 1600 × 1200 | 75.0/60 | ● | ● |
| 1280 × 768 | 47.8/60 | | ● |
| 1280 × 720 | 45.0/60 | ● | ● ^{*5} |
| 1920 × 1080 | 67.5/60 | | ● ^{*3} |
| 1366 × 768 | 47.7/60 | ● | ● |
| 1440 × 900 | 55.9/60 | ● | ● |

| Resolution | fH[kHz]/ fV[Hz] | Input connector | |
|-------------|--------------------|-----------------|-----------------|
| | | RGB/ YPbPr | HDMI |
| 1680 × 1050 | 65.3/60 | ● | ● |
| 1280 × 800 | 49.7/60 | ● | ● |
| 1920 × 1200 | 74.0/60 | ● ^{*5} | ● ^{*5} |
| 1600 × 900 | 60.0/60 | ● ^{*5} | ● ^{*5} |

Video signal

| Signal | fV[Hz] | Input connector | | |
|---------------|--------|-------------------|-----------------------|---------------------------------|
| | | VIDEO/ S VIDEO | INPUT A ^{*4} | INPUT B/ INPUT C/ INPUT D |
| NTSC | 60 | ● | – | – |
| PAL/ SECAM | 50 | ● | – | – |
| | | 480i | 60 | – |
| 576i | 50 | – | ● | ● |
| 480p | 60 | – | ● | ● |
| 576p | 50 | – | ● | ● |
| 1080i | 60 | – | ● | ● |
| 1080i | 50 | – | ● | ● |
| 720p | 60 | – | ● | ● |
| 720p | 50 | – | ● | ● |
| 1080p | 60 | – | – | ● |
| 1080p | 50 | – | – | ● |
| 1080p | 24 | – | – | ● |

Notes

- *1: ● When a signal other than the signals listed in table is input, the picture may not be displayed properly.
- An input signal meant for screen resolution different from that of the panel will not be displayed in its original resolution. Text and lines may be uneven.
- *2: This is identified as a movie delivery signal of 720/60p.
- *3: This is identified as a movie delivery signal of 1080/60p.
- *4: Only G with sync/Y is supported.
- *5: Only VESA Reduced Blanking is supported.

Projection Distance and Lens Shift Range

The following describes the projection distance and height from lens center to bottom of screen by each projected screen size.

The projection distance is the distance between the front of the lens and the surface of the projected image.

Height H is the height from the bottom of the projected image (top for ceiling mount) to A (determined by drawing a perpendicular line from lens center to projected image surface). For this unit, the same projection distance calculations apply to both floor and ceiling installation.

Floor Installation/Ceiling Installation (Top side parallel to ceiling)

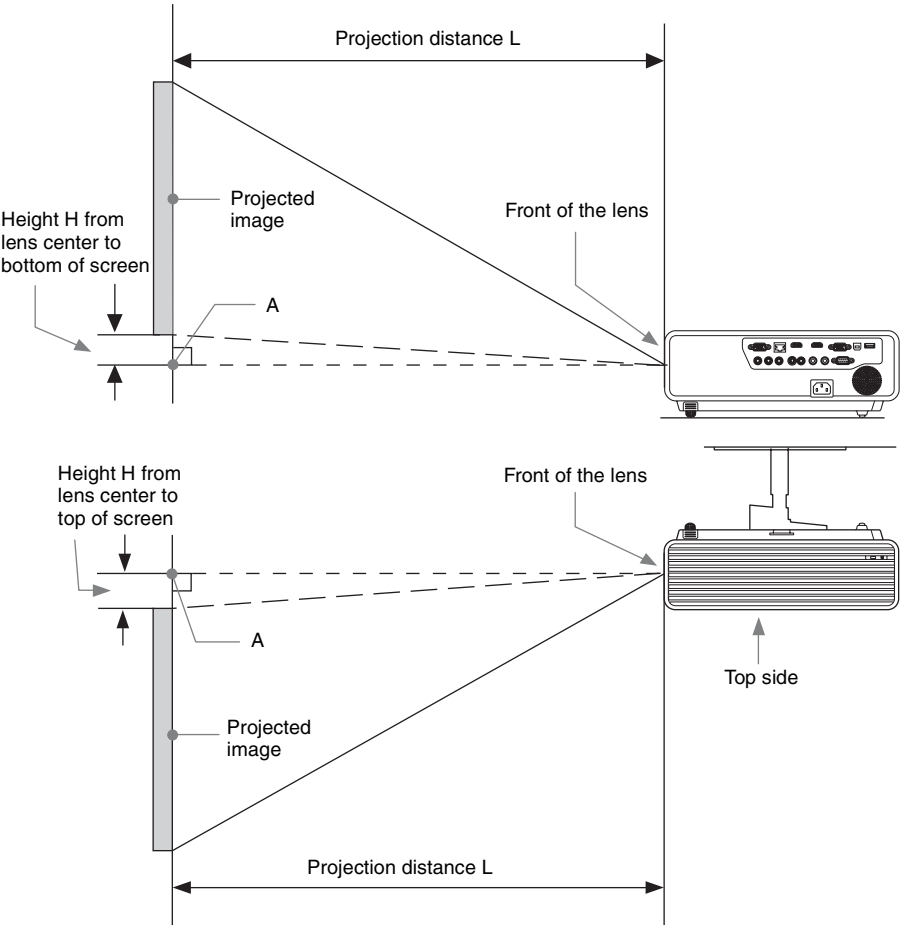

The lens shift range represents the distance in percent (%) by which the lens can be shifted from the initial position of the projected image, with full width or full height of the projected image regarded as 100%.

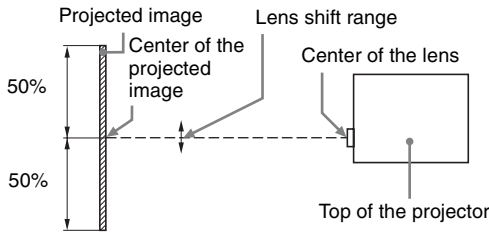
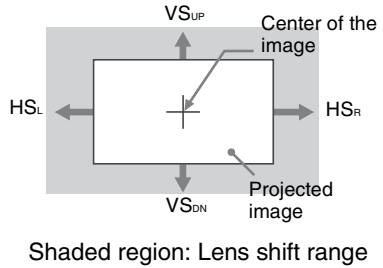
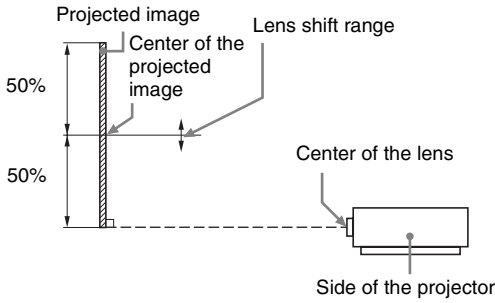

- VS_{UP}: Vertical lens shift range (up) [%]
- VS_{DN}: Vertical lens shift range (down) [%]
- HS_R: Horizontal lens shift range (right) [%]
- HS_L: Horizontal lens shift range (left) [%]

Projection distance/Projection distance formula

Projection distance

Unit: m (inches)

| Projected image size | | Projection Distance L | Height H from lens center to bottom of screen | |
|----------------------|----------------------------|----------------------------|---|-----------------------|
| Diagonal D | Width × Height | | Projection Distance L | Projection Distance L |
| 80 inch (2.03m) | 1.72 × 1.08 (68 × 42) | 2.59 – 3.83 (102 – 150) | 0.09 (4) | 0.09 (4) |
| 100 inch (2.54m) | 2.15 × 1.35 (85 × 53) | 3.24 – 4.80 (128 – 189) | 0.11 (4) | 0.11 (4) |
| 120 inch (3.05m) | 2.58 × 1.62 (102 × 64) | 3.90 – 5.77 (154 – 227) | 0.13 (5) | 0.13 (5) |
| 150 inch (3.81m) | 3.23 × 2.02 (127 × 79) | 4.89 – 7.22 (193 – 284) | 0.17 (7) | 0.17 (7) |
| 200 inch (5.08m) | 4.31 × 2.69 (170 × 106) | 6.53 – 9.65 (258 – 380) | 0.22 (9) | 0.22 (9) |

Projection distance formula

D: Projected image size (Diagonal)

H: Distance between the bottom edge of the image and the center of the lens

Expression#1 (Projection distance L)

Unit: m (inches)

| Minimum Projection Distance L | Maximum Projection Distance L |
|--|--|
| $L=0.032886 \times D-0.0487$ $(L=1.294738 \times D-1.9185)$ | $L=0.048506 \times D-0.0485$ $(L=1.909676 \times D-1.9097)$ |

Expression#2 (Height H from center of lens to edge of screen)

Unit: m (inches)

| Height H from lens center to bottom of screen | |
|--|--|
| Minimum Projection Distance L | Maximum Projection Distance L |
| $H=0.00112 \times D+0.00000$ $(H=0.04417 \times D+0.00000)$ | $H=0.00112 \times D+0.00000$ $(H=0.04417 \times D+0.00000)$ |

Others

Lens shift range

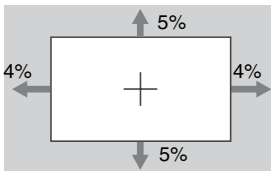

$$VS_{UP}=VS_{DN}=5[\%]$$

$$HS_R=HS_L=4[\%]$$

Dimensions

Front

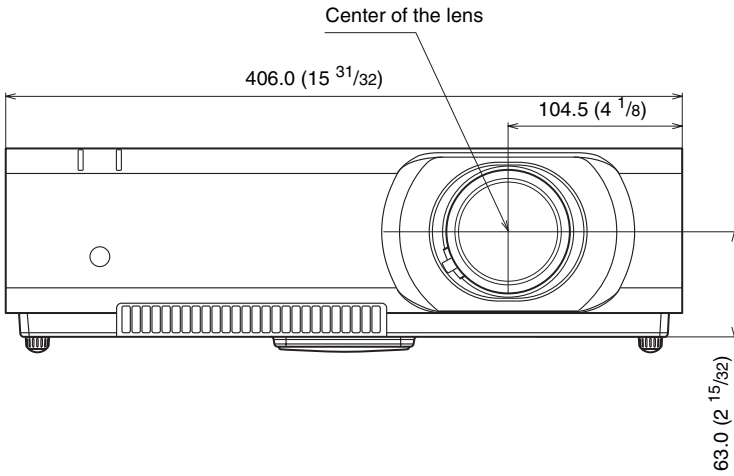

Unit: mm (inches)

Side

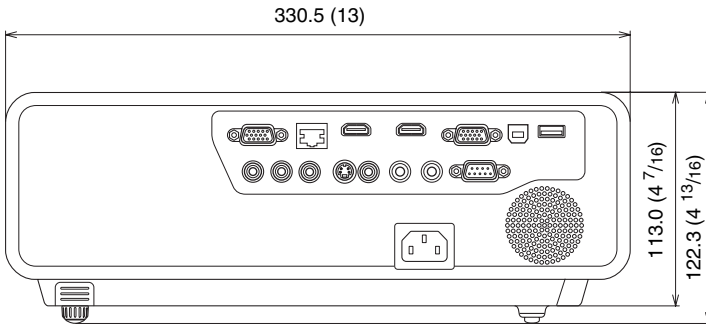

Unit: mm (inches)

Bottom

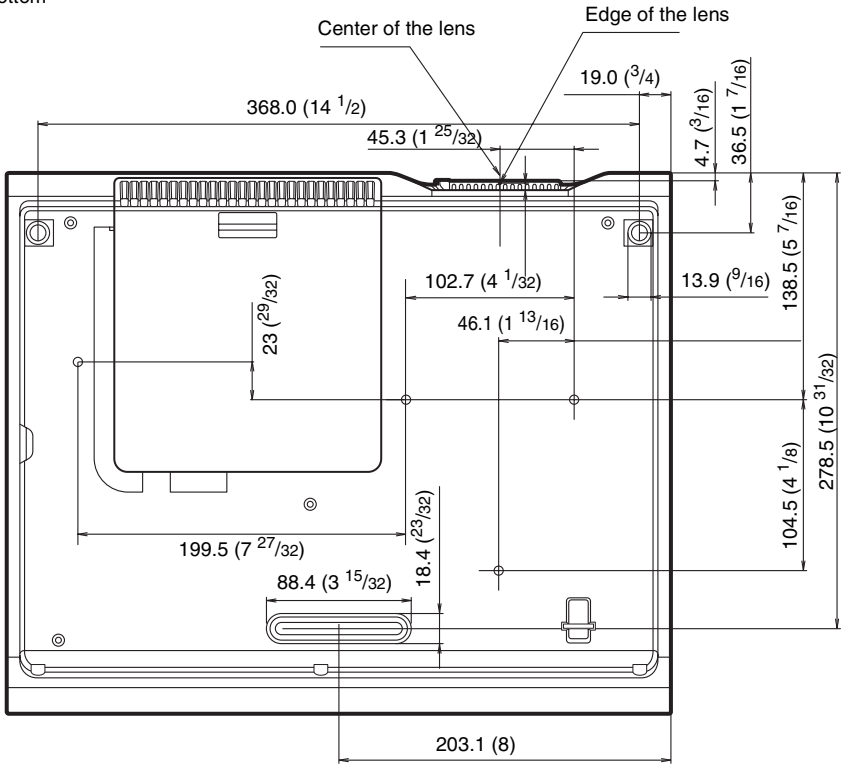

Unit: mm (inches)

Others

END USER LICENSE AGREEMENT

IMPORTANT:

BEFORE USING THE SOFTWARE, PLEASE READ THIS END USER LICENSE AGREEMENT (“EULA”) CAREFULLY. BY USING THE SOFTWARE YOU ARE ACCEPTING THE TERMS OF THIS EULA. IF YOU DO NOT ACCEPT THE TERMS OF THIS EULA, YOU MAY NOT USE THE SOFTWARE.

This EULA is a legal agreement between you and Sony Corporation (“SONY”). This EULA governs your rights and obligations regarding the software of SONY and/or its third party licensors (including SONY’s affiliates) and their respective affiliates (collectively, the “THIRD-PARTY SUPPLIERS”), together with any updates/upgrades provided by SONY, any printed, on-line or other electronic documentation for such software, and any data files created by operation of such software (collectively, the “SOFTWARE”).

Notwithstanding the foregoing, any software in the SOFTWARE having a separate end user license agreement (including, but not limited to, GNU General Public license and Lesser/Library General Public License) shall be covered by such applicable separate end user license agreement in lieu of the terms of this EULA to the extent required by such separate end user license agreement (“EXCLUDED SOFTWARE”).

SOFTWARE LICENSE

The SOFTWARE is licensed, not sold. The SOFTWARE is protected by copyright and other intellectual property laws and international treaties.

COPYRIGHT

All right and title in and to the SOFTWARE (including, but not limited to, any images, photographs, animation, video, audio, music, text and “applets” incorporated into the SOFTWARE) is owned by SONY or one

or more of the THIRD-PARTY SUPPLIERS.

GRANT OF LICENSE

SONY grants you a limited license to use the SOFTWARE solely in connection with your compatible device (“DEVICE”) and only for your individual, non-commercial use. SONY and the THIRD-PARTY SUPPLIERS expressly reserve all rights, title and interest (including, but not limited to, all intellectual property rights) in and to the SOFTWARE that this EULA does not specifically grant to you.

REQUIREMENTS AND LIMITATIONS

You may not copy, publish, adapt, redistribute, attempt to derive source code, modify, reverse engineer, decompile, or disassemble any of the SOFTWARE, whether in whole or in part, or create any derivative works from or of the SOFTWARE unless such derivative works are intentionally facilitated by the SOFTWARE. You may not modify or tamper with any digital rights management functionality of the SOFTWARE. You may not bypass, modify, defeat or circumvent any of the functions or protections of the SOFTWARE or any mechanisms operatively linked to the SOFTWARE. You may not separate any individual component of the SOFTWARE for use on more than one DEVICE unless expressly authorized to do so by SONY. You may not remove, alter, cover or deface any trademarks or notices on the SOFTWARE. You may not share, distribute, rent, lease, sublicense, assign, transfer or sell the SOFTWARE. The software, network services or other products other than SOFTWARE upon which the SOFTWARE’S performance depends might be interrupted or discontinued at the discretion of the suppliers (software suppliers, service suppliers, or SONY). SONY and such suppliers do not warrant that the SOFTWARE, network services, contents or other products will continue to be available, or will operate without interruption or modification.

EXCLUDED SOFTWARE AND OPEN SOURCE COMPONENTS

Notwithstanding the foregoing limited license grant, you acknowledge that the SOFTWARE may include EXCLUDED SOFTWARE. Certain EXCLUDED SOFTWARE may be covered by open source software licenses (“Open Source Components”), which means any software licenses approved as open source licenses by the Open Source Initiative or any substantially similar licenses, including but not limited to any license that, as a condition of distribution of the software licensed under such license, requires that the distributor make the software available in source code format. If and to the extent disclosure is required, please visit www.sony.net/Products/Linux or other SONY-designated web site for a list of applicable OPEN SOURCE COMPONENTS included in the SOFTWARE from time to time, and the applicable terms and conditions governing its use. Such terms and conditions may be changed by the applicable third party at any time without liability to you. To the extent required by the licenses covering EXCLUDED SOFTWARE, the terms of such licenses will apply in lieu of the terms of this EULA. To the extent the terms of the licenses applicable to EXCLUDED SOFTWARE prohibit any of the restrictions in this EULA with respect to such EXCLUDED SOFTWARE, such restrictions will not apply to such EXCLUDED SOFTWARE. To the extent the terms of the licenses applicable to Open Source Components require SONY to make an offer to provide source code in connection with the SOFTWARE, such offer is hereby made.

USE OF SOFTWARE WITH COPYRIGHTED MATERIALS

The SOFTWARE may be capable of being used by you to view, store, process and/or use content created by you and/or third parties. Such content may be protected by copyright, other intellectual property laws, and/or agreements. You agree to use the SOFTWARE only in compliance with all such laws and agreements that apply to such content. You acknowledge and agree that

SONY may take appropriate measures to protect the copyright of content stored, processed or used by the SOFTWARE. Such measures include, but are not limited to, counting the frequency of your backup and restoration through certain SOFTWARE features, refusal to accept your request to enable restoration of data, and termination of this EULA in the event of your illegitimate use of the SOFTWARE.

CONTENT SERVICE

PLEASE ALSO NOTE THAT THE SOFTWARE MAY BE DESIGNED TO BE USED WITH CONTENT AVAILABLE THROUGH ONE OR MORE CONTENT SERVICES (“CONTENT SERVICE”). USE OF THE SERVICE AND THAT CONTENT IS SUBJECT TO THE TERMS OF SERVICE OF THAT CONTENT SERVICE. IF YOU DECLINE TO ACCEPT THOSE TERMS, YOUR USE OF THE SOFTWARE WILL BE LIMITED. You acknowledge and agree that certain content and services available through the SOFTWARE may be provided by third parties over which SONY has no control. USE OF THE CONTENT SERVICE REQUIRES AN INTERNET CONNECTION. THE CONTENT SERVICE MAY BE DISCONTINUED AT ANY TIME.

INTERNET CONNECTIVITY AND THIRD PARTY SERVICES

You acknowledge and agree that access to certain SOFTWARE features may require an Internet connection for which you are solely responsible. Further, you are solely responsible for payment of any third party fees associated with your Internet connection, including but not limited to Internet service provider or airtime charges. Operation of the SOFTWARE may be limited or restricted depending on the capabilities, bandwidth or technical limitations of your Internet connection and service. The provision, quality and security of such Internet connectivity are the sole responsibility of the third party providing such service.

EXPORT AND OTHER REGULATIONS

You agree to comply with all applicable export and re-export restrictions and regulations of the area or country in which you reside, and not to transfer, or authorize the transfer, of the SOFTWARE to a prohibited country or otherwise in violation of any such restrictions or regulations.

HIGH RISK ACTIVITIES

The SOFTWARE is not fault-tolerant and is not designed, manufactured or intended for use or resale as on-line control equipment in hazardous environments requiring fail-safe performance, such as in the operation of nuclear facilities, aircraft navigation or communication systems, air traffic control, direct life support machines, or weapons systems, in which the failure of the SOFTWARE could lead to death, personal injury, or severe physical or environmental damage (“HIGH RISK ACTIVITIES”). SONY, each of the THIRD-PARTY SUPPLIERS, and each of their respective affiliates specifically disclaim any express or implied warranty, duty or condition of fitness for HIGH RISK ACTIVITIES.

EXCLUSION OF WARRANTY ON SOFTWARE

You acknowledge and agree that use of the SOFTWARE is at your sole risk and that you are responsible for use of the SOFTWARE. The SOFTWARE is provided “AS IS,” without warranty, duty or condition of any kind.

SONY AND EACH OF THE THIRD-PARTY SUPPLIERS (for purposes of this Section, SONY and each of the THIRD-PARTY SUPPLIERS shall be collectively referred to as “SONY”) EXPRESSLY DISCLAIM ALL WARRANTIES, DUTIES OR CONDITIONS, EXPRESS OR IMPLIED, INCLUDING, BUT NOT LIMITED TO, THE IMPLIED WARRANTIES OF MERCHANTABILITY, NONINFRINGEMENT AND FITNESS FOR A PARTICULAR PURPOSE. SONY DOES NOT WARRANT OR MAKE ANY CONDITIONS OR REPRESENTATIONS (A) THAT THE FUNCTIONS

CONTAINED IN ANY OF THE SOFTWARE WILL MEET YOUR REQUIREMENTS OR THAT THEY WILL BE UPDATED, (B) THAT THE OPERATION OF ANY OF THE SOFTWARE WILL BE CORRECT OR ERROR-FREE OR THAT ANY DEFECTS WILL BE CORRECTED, (C) THAT THE SOFTWARE WILL NOT DAMAGE ANY OTHER SOFTWARE, HARDWARE OR DATA, (D) THAT ANY SOFTWARE, NETWORK SERVICES (INCLUDING THE INTERNET) OR PRODUCTS (OTHER THAN THE SOFTWARE) UPON WHICH THE SOFTWARE’S PERFORMANCE DEPENDS WILL CONTINUE TO BE AVAILABLE, UNINTERRUPTED OR UNMODIFIED, AND (E) REGARDING THE USE OR THE RESULTS OF THE USE OF THE SOFTWARE IN TERMS OF ITS CORRECTNESS, ACCURACY, RELIABILITY, OR OTHERWISE.

NO ORAL OR WRITTEN INFORMATION OR ADVICE GIVEN BY SONY OR AN AUTHORIZED REPRESENTATIVE OF SONY SHALL CREATE A WARRANTY, DUTY OR CONDITION OR IN ANY WAY INCREASE THE SCOPE OF THIS WARRANTY. SHOULD THE SOFTWARE PROVE DEFECTIVE YOU ASSUME THE ENTIRE COST OF ALL NECESSARY SERVICING, REPAIR OR CORRECTION. SOME JURISDICTIONS DO NOT ALLOW THE EXCLUSION OF IMPLIED WARRANTIES, SO THESE EXCLUSIONS MAY NOT APPLY TO YOU.

LIMITATION OF LIABILITY

SONY AND EACH OF THE THIRD-PARTY SUPPLIERS (for purposes of this Section, SONY and each of the THIRD-PARTY SUPPLIERS shall be collectively referred to as “SONY”) SHALL NOT BE LIABLE FOR ANY INCIDENTAL OR CONSEQUENTIAL DAMAGES FOR BREACH OF ANY EXPRESS OR IMPLIED WARRANTY, BREACH OF CONTRACT, NEGLIGENCE, STRICT LIABILITY OR UNDER ANY OTHER

LEGAL THEORY RELATED TO THE SOFTWARE, INCLUDING, BUT NOT LIMITED TO, ANY DAMAGES ARISING OUT OF LOSS OF PROFITS, LOSS OF REVENUE, LOSS OF DATA, LOSS OF USE OF THE SOFTWARE OR ANY ASSOCIATED HARDWARE, DOWN TIME AND USER'S TIME, EVEN IF ANY OF THEM HAVE BEEN ADVISED OF THE POSSIBILITY OF SUCH DAMAGES. IN ANY CASE, EACH AND ALL OF THEIR AGGREGATE LIABILITY UNDER ANY PROVISION OF THIS EULA SHALL BE LIMITED TO THE AMOUNT ACTUALLY PAID FOR THE PRODUCT. SOME JURISDICTIONS DO NOT ALLOW THE EXCLUSION OR LIMITATION OF INCIDENTAL OR CONSEQUENTIAL DAMAGES, SO THE ABOVE EXCLUSION OR LIMITATION MAY NOT APPLY TO YOU.

CONSENT TO USE OF NON- PERSONAL INFORMATION, LOCATION DATA, DATA SECURITY

You acknowledge and agree that SONY and its affiliates, partners and agents may read, collect, transfer, process and store certain information collected from the SOFTWARE, including but not limited to information about (i) the SOFTWARE and (ii) the software applications, contents and peripheral devices that interact with your DEVICE and the SOFTWARE (“Information”). Information includes, but is not limited to: (1) unique identifiers relating to your DEVICE and its components; (2) performance of the DEVICE, the SOFTWARE and their components; (3) configurations of your DEVICE, the SOFTWARE and the software applications, contents and peripheral devices that interact with the DEVICE and the SOFTWARE; (4) use and frequency of use of the functions of (x) the SOFTWARE, and (y) the software applications, contents and peripheral devices that interact with the SOFTWARE; and (5) location data, as indicated below. SONY and its affiliates, partners and agents may use and disclose Information subject to applicable laws in order to improve its products and services or to provide products or services to you. Such uses include, but are

not limited to: (a) administering the functionalities of the SOFTWARE; (b) to improve, service, update or upgrade the SOFTWARE; (c) improving, developing and enhancing the current and future products and services of SONY and other parties; (d) to provide you with information about the products and services offered by SONY and other parties; (e) complying with applicable laws or regulations; and (f) to the extent offered, providing you with location-based services of SONY and other parties, as indicated below. In addition, SONY retains the right to use Information to protect itself and third parties from illegal, criminal or harmful conduct.

Certain services available through the SOFTWARE may rely upon location information, including, but not limited to, the geographic location of the DEVICE. You acknowledge that for the purpose of providing such services, SONY, the THIRD-PARTY SUPPLIERS or their partners may collect, archive, process and use such location data, and that such services are governed by the privacy policies of SONY or such third party. By using any such services, you agree that you have reviewed the privacy policies applicable to such services and consent to such activities.

SONY, its affiliates, partners and agents will not intentionally use Information to personally identify the owner or user of the SOFTWARE without your knowledge or consent. Any use of Information will be in accordance with the privacy policies of SONY or such third party. Please contact applicable contact address of each area or country for SONY's current privacy policy.

Please contact applicable third parties for privacy policies relating to personally identifiable and other information you provide when you use or access third party software or services.

Information may be processed, stored or transferred to SONY, its affiliates or agents which are located in countries outside of your country of residence. Data protection and information privacy laws in certain

countries may not offer the same level of protection as your country of residence and you may have fewer legal rights in relation to Information processed and stored in, or transferred to, such countries. SONY will use reasonable efforts to take appropriate technical and organizational steps to prevent unauthorized access to or disclosure of Information, but does not warrant it will eliminate all risk of misuse of such Information.

AUTOMATIC UPDATE FEATURE

From time to time, SONY or the THIRD-PARTY SUPPLIERS may automatically update or otherwise modify the SOFTWARE, including, but not limited to, for purposes of enhancement of security functions, error correction and improvement of functions, at such time as you interact with SONY's or third parties' servers, or otherwise. Such updates or modifications may delete or change the nature of features or other aspects of the SOFTWARE, including, but not limited to, functions you may rely upon. You acknowledge and agree that such activities may occur at SONY's sole discretion and that SONY may condition continued use of the SOFTWARE upon your complete installation or acceptance of such update or modifications. Any updates/modifications shall be deemed to be, and shall constitute part of, the SOFTWARE for purposes of this EULA. By acceptance of this EULA, you consent to such update/modification.

ENTIRE AGREEMENT, WAIVER, SEVERABILITY

This EULA and SONY's privacy policy, each as amended and modified from time to time, together constitute the entire agreement between you and SONY with respect to the SOFTWARE. The failure of SONY to exercise or enforce any right or provision of this EULA shall not constitute a waiver of such right or provision. If any part of this EULA is held invalid, illegal, or unenforceable, that provision shall be enforced to the maximum extent permissible so as to maintain the intent of this EULA, and the other parts will remain in full force and effect.

GOVERNING LAW AND JURISDICTION

The United Nations Convention on Contracts for the International Sale of Goods shall not apply to this EULA. This EULA shall be governed by the laws of Japan, without regards to conflict of laws provisions. Any dispute arising out of this EULA shall be subject to the exclusive venue of the Tokyo District Court in Japan, and the parties hereby consent to the venue and jurisdiction of such courts.

EQUITABLE REMEDIES

Notwithstanding anything contained in this EULA to the contrary, you acknowledge and agree that any violation of or non-compliance with this EULA by you will cause irreparable harm to SONY, for which monetary damages would be inadequate, and you consent to SONY obtaining any injunctive or equitable relief that SONY deems necessary or appropriate in such circumstances. SONY may also take any legal and technical remedies to prevent violation of and/or to enforce this EULA, including, but not limited to, immediate termination of your use of the SOFTWARE, if SONY believes in its sole discretion that you are violating or intend to violate this EULA. These remedies are in addition to any other remedies SONY may have at law, in equity or under contract.

TERMINATION

Without prejudice to any of its other rights, SONY may terminate this EULA if you fail to comply with any of its terms. In case of such termination, you must: (i) cease all use, and destroy any copies, of the SOFTWARE; (ii) comply with the requirements in the section below entitled "Your Account Responsibilities".

AMENDMENT

SONY RESERVES THE RIGHT TO AMEND ANY OF THE TERMS OF THIS EULA AT ITS SOLE DISCRETION BY POSTING NOTICE ON A SONY DESIGNATED WEB SITE, BY EMAIL NOTIFICATION TO AN EMAIL ADDRESS PROVIDED BY YOU, BY PROVIDING NOTICE AS PART OF THE

PROCESS IN WHICH YOU OBTAIN UPGRADES/UPDATES OR BY ANY OTHER LEGALLY RECOGNIZABLE FORM OF NOTICE. If you do not agree to the amendment, you should promptly contact SONY for instructions. Your continued use of the SOFTWARE after the effective date of any such notice shall be deemed your agreement to be bound by such amendment.

THIRD-PARTY BENEFICIARIES

Each THIRD-PARTY SUPPLIER is an express intended third-party beneficiary of, and shall have the right to enforce, each provision of this EULA with respect to the SOFTWARE of such party.

YOUR ACCOUNT RESPONSIBILITIES

Should you return your DEVICE to its place of purchase, sell or otherwise transfer your DEVICE, or if this EULA is terminated, you are responsible for and must uninstall the SOFTWARE from the DEVICE and delete any and all accounts you may have established on DEVICE or are accessible through the SOFTWARE. You are solely responsible for maintaining the confidentiality of any accounts you have with SONY OR third parties and any usernames and passwords associated with YOUR USE OF the DEVICE.

Should you have any questions concerning this EULA, you may contact SONY by writing to SONY at applicable contact address of each area or country.

Copyright © 2012 Sony Corporation.

Index

A

| | |
|--|-----------|
| AC IN | 6 |
| Acceptable input signal | 66 |
| Adjust Signal | 26 |
| Adjusting lens shift | 19 |
| Air filter | 60 |
| Air filter cover/Ventilation holes (intake) | 4 |
| APA | 7 |
| Aspect | 7, 26, 28 |

B

| | |
|------------------|----|
| BLANK | 7 |
| Brightness | 25 |

C

| | |
|---|------|
| CC Display | 29 |
| Color | 25 |
| Color Matching | 34 |
| Color Temp. | 25 |
| Connecting a computer | 9 |
| Connecting a Video equipment | 11 |
| Connecting an external monitor and audio equipment | 16 |
| Connector panel | 4, 5 |
| Constant Brightness | 31 |
| Contrast | 25 |
| Control Key Lock | 30 |
| Control Panel Keys | 7 |
| Correcting trapezoidal distortion of the projected image (Keystone feature) | 7 |

D

| | |
|--------------------|---|
| Digital Zoom | 7 |
|--------------------|---|

E

| | |
|-------------------------------------|---|
| ECO MODE (Energy-saving mode) | 8 |
|-------------------------------------|---|

F

| | |
|-------------------------------|-------|
| fH | 36 |
| Focus | 18 |
| Focus ring | 4 |
| Freeze | 7 |
| Front feet (adjustable) | 4, 20 |
| fV | 36 |

G

| | |
|------------------|----|
| Gamma Mode | 25 |
|------------------|----|

H

| | |
|--------------------------|----|
| H (Horizontal) | 26 |
| H Keystone | 34 |
| HDBaseT connector | 5 |
| High Altitude Mode | 34 |
| Hue | 25 |

I

| | |
|-----------------------------|----|
| Image Flip | 34 |
| Information menu | 36 |
| Input | 5 |
| Installation Attitude | 34 |
| Installation menu | 34 |
| IR Receiver | 30 |

K

| | |
|----------------|---|
| Keystone | 7 |
|----------------|---|

L

| | |
|---|-------|
| Lamp cover | 4 |
| Lamp Timer | 36 |
| Lamp Timer Reset | 29 |
| LAMP/COVER indicator | 4, 53 |
| LAN connector | 5 |
| Language | 30 |
| Lens shift cover | 4, 19 |
| Location and function of controls | 4 |

M

| | |
|---------------------|----|
| Main unit | 4 |
| Menu Position | 30 |
| Messages list | 54 |
| Model Name | 36 |
| MUTING | 7 |

N

| | |
|------------------------|----|
| Network Features | 37 |
|------------------------|----|

O

| | |
|----------------------------|----|
| ON/STANDBY indicator | 4 |
| Operation menu | 30 |
| Output | 6 |

P

| | |
|-----------------------|----|
| Panel Alignment | 34 |
|-----------------------|----|

| | |
|---|----|
| Phase, Pitch, Shift | 26 |
| Picture menu | 25 |
| Picture mode | 25 |
| Pin assignment | 64 |
| Projecting an image | 17 |
| Projection distance | 67 |
| Projector Station for Network Presentation | 47 |

R

| | |
|-------------------------------|----|
| Remote commander | 7 |
| Remote control detector | 4 |
| Replacing the lamp | 58 |
| Reset | 25 |
| RS-232C | 6 |

S

| | |
|---------------------------------|-------|
| Security bar | 4 |
| Security Lock | 4, 30 |
| Selecting an input signal | 7 |
| Serial No. | 36 |
| Sharpness | 25 |
| Signal Type | 36 |
| Smart APA | 29 |
| Speaker | 29 |
| Specifications | 61 |
| Start Up Image | 29 |
| Status | 30 |

T

| | |
|---------------------------------|-------|
| The Connection/Power Menu | 31 |
| The Function menu | 29 |
| The Screen menu | 26 |
| Troubleshooting | 55 |
| Turn off | 7, 23 |
| Turn on | 7, 17 |

U

| | |
|--|----|
| USB Display | 51 |
| Using a menu | 24 |
| Using the e-mail report Function | 39 |

V

| | |
|-------------------------|-----------|
| V Keystone | 7, 20, 34 |
| Ventilation holes | 4 |
| Volume | 7 |

W

| | |
|---------------------|--------|
| Warping | 21, 34 |
| With No Input | 32 |

| | |
|--------------------------|----|
| With Static Signal | 32 |
|--------------------------|----|

Z

| | |
|------------------|---|
| Zoom lever | 4 |
|------------------|---|



About Trademarks

- Adobe and Adobe Acrobat are trademarks or registered trademarks of Adobe Systems Incorporated in the United States and/or other countries.
- Kensington is a registered trademark of Kensington Technology Group.
- The terms HDMI and HDMI High-Definition Multimedia Interface, and the HDMI Logo are trademarks or registered trademarks of HDMI Licensing LLC in the United States and other countries.
- Internet Explore is registered trademarks of Microsoft Corporation in the United States and/or other countries.
- PJLink is a registered trademark of Japan Business Machine and Information System Industries Association.
- AMX is a trademark of AMX Corporation.
- Crestron RoomView is a trademark of Crestron Corporation.
- Mac and Mac OS are registered trademarks of Apple Inc. in the U.S. and other countries.
- HDBaseT™ and the HDBaseT Alliance logo are trademarks of the HDBaseT Alliance.
- All other trademarks and registered trademarks are trademarks or registered trademarks of their respective holders. In this manual, ™ and ® marks are not specified.

