



MG23H3115\*\*

# Microwave Oven

## Owner's Instructions & Cooking Guide

Please be advised that the Samsung warranty does NOT cover service calls to explain product operation, correct improper installation, or perform normal cleaning or maintenance.

**Planet First** 100 %  
Recycled Paper

This manual is made with 100 % recycled paper.

imagine the possibilities

Thank you for purchasing this Samsung product.  
To receive more complete service, please register  
your product at

[www.samsung.com/register](http://www.samsung.com/register)



## contents

<b>Safety information</b> .....	<b>2</b>
<b>Quick look-up guide</b> .....	<b>11</b>
<b>Oven features</b> .....	<b>12</b>
Oven .....	12
Control panel .....	13
Accessories .....	13
<b>Oven use</b> .....	<b>14</b>
How a microwave oven works .....	14
Checking that your oven is operating correctly .....	14
Setting the time .....	15
Cooking/Reheating .....	15
Power levels .....	16
Adjusting the cooking time .....	16
Stopping the cooking .....	16
Setting the energy save mode .....	16
Using the steam cleaning (Only MG23H3115B*, MG23H3115N*, MG23H3115P*, MG23H3115X* models) .....	17
Using the russia cuisine features .....	17
Using the healthy cooking features .....	22
Power steam cooking guide (Only MG23H3115P*, MG23H3115X* models) .....	24
Using the crusty plate (Only MG23H3115N*, MG23H3115X* models) .....	26
Using the auto power defrost features .....	27
Using the my plate features .....	28
Choosing the accessories .....	29
Grilling .....	29
Combining microwaves and the grill .....	30
Switching the beeper off .....	30
Safety-locking your microwave oven .....	30
<b>Cookware guide</b> .....	<b>31</b>
<b>Cooking guide</b> .....	<b>32</b>
<b>Troubleshooting and error code</b> .....	<b>39</b>
Troubleshooting .....	39
Error code .....	40
<b>Technical specifications</b> .....	<b>40</b>















## safety information

### USING THIS INSTRUCTION BOOKLET

You have just purchased a SAMSUNG microwave oven. Your Owner's Instructions contain valuable information on cooking with your microwave oven:

- Safety precautions
- Suitable accessories and cookware
- Useful cooking tips
- Cooking tips

### LEGEND FOR SYMBOLS AND ICONS

	<b>WARNING</b>	Hazards or unsafe practices that may result in <b>severe personal injury or death.</b>	
	<b>CAUTION</b>	Hazards or unsafe practices that may result in <b>minor personal injury or property damage.</b>	
	Warning; Fire hazard		Warning; Hot surface
	Warning; Electricity		Warning; Explosive material
	Do NOT attempt.		Do NOT touch.
	Do NOT disassemble.		Follow directions explicitly.
	Unplug the power plug from the wall socket.		Make sure the machine is grounded to prevent electric shock.
	Call the service center for help.		Note
	Important		

## IMPORTANT SAFETY INSTRUCTIONS

### READ CAREFULLY AND KEEP FOR FUTURE REFERENCE.

Make sure that these safety precautions are obeyed at all times.

**Before using the oven, confirm that the following instructions are followed.**







 <b>WARNING</b> (Microwave function only)	
<input type="checkbox"/>	<b>WARNING:</b> If the door or door seals are damaged, the oven must not be operated until it has been repaired by a competent person.
<input type="checkbox"/>	<b>WARNING:</b> It is hazardous for anyone other than a competent person to carry out any service or repair operation that involves the removal of a cover which gives protection against exposure to microwave energy.
<input checked="" type="checkbox"/>	This appliance is intended to be used in household only.

<input checked="" type="checkbox"/>	<b>WARNING:</b> Only allow children to use the oven without supervision when adequate instructions have been given so that the child is able to use the oven in a safe way and understands the hazards of improper use.
<input checked="" type="checkbox"/>	<b>WARNING:</b> This appliance can be used by children aged from 8 years and above and persons with reduced physical, sensory or mental capabilities or lack of experience and knowledge if they have been given supervision or instruction concerning use of the appliance in a safe way and understand the hazards involved. Children shall not play with the appliance. Cleaning and user maintenance shall not be made by children unless they are aged from 8 years and above and supervised.
<input checked="" type="checkbox"/>	Only use utensils that are suitable for use in microwave ovens.
<input checked="" type="checkbox"/>	When heating food in plastic or paper containers, keep an eye on the oven due to the possibility of ignitions.

★	The microwave oven is intended for heating food and beverages. Drying of food or clothing and heating of warming pads, slippers, sponges, damp cloth and similar may lead to risk of injury, ignition or fire.
☞	If smoke is emitted, switch off or unplug the appliance and keep the door closed in order to stifle any flames.
★	<b>WARNING:</b> Microwave heating of beverages can result in delayed eruptive boiling, therefore care must be taken when handling the container.
★	<b>WARNING:</b> The contents of feeding bottles and baby food jars shall be stirred or shaken and the temperature checked before consumption, in order to avoid burns.
☒	Eggs in their shell and whole hard-boiled eggs should not be heated in microwave ovens since they may explode, even after microwave heating has ended.
★	The oven should be cleaned regularly and any food deposits removed.







☞	Failure to maintain the oven in a clean condition could lead to deterioration of the surface that could adversely affect the life of the appliance and possibly result in a hazardous situation.
☒	The appliance is not intended for installing in road vehicles, caravans and similar vehicles etc.
★	This appliance is not intended for use by persons (including children) with reduced physical, sensory or mental capabilities, or lack of experience and knowledge, unless they have been given supervision or instruction concerning use of the appliance by a person responsible for their safety.
★	Children should be supervised to ensure that they do not play with the appliance.
☞	If the supply cord is damaged, it must be replaced by the manufacturer, its service agent or similarly qualified persons in order to avoid a hazard.
☒	<b>WARNING:</b> Liquids or other foods must not be heated in sealed containers since they are liable to explode;



	The appliance should not be cleaned with a water jet.
	This oven should be positioned proper direction and height permitting easy access to cavity and control area.
	Before using the your oven first time, oven should be operated with the water during 10 minute and then used.
	If the oven generates a strange noise, a burning smell, or smoke is emitted, unplug the power plug immediately and contact your nearest service center.
	The microwave oven has to be positioned so that plug is accessible.
	The microwave oven is intended to be used on the counter or counter top use only, the microwave oven shall not be placed in a cabinet.

 **WARNING**  
(Oven function only) - Optional

	<b>WARNING:</b> When the appliance is operated in the combination mode, children should only use the oven under adult supervision due to the temperatures generated.
---	--

	During use the appliance becomes hot. Care should be taken to avoid touching heating elements inside the oven.
	<b>WARNING:</b> Accessible parts may become hot during use. Young children should be kept away.
	A steam cleaner is not to be used.
	<b>WARNING:</b> Ensure that the appliance is switched off before replacing the lamp to avoid the possibility of electric shock.
	<b>WARNING:</b> The appliance and its accessible parts become hot during use. Care should be taken to avoid touching heating elements. Children less than 8 years of age shall be kept away unless continuously supervised.
	The temperature of accessible surfaces may be high when the appliance is operating.
	The door or the outer surface may get hot when the appliance is operating.
	Keep the appliance and its cord out of reach of children less than 8 years.

★	This appliance can be used by children aged from 8 years and above and persons with reduced physical, sensory or mental capabilities or lack of experience and knowledge if they have been given supervision or instruction concerning use of the appliance in a safe way and understand the hazards involved. Children shall not play with the appliance. Cleaning and user maintenance shall not be made by children without supervision.
☒	Do not use harsh abrasive cleaners or sharp metal scrapers to clean the oven door glass since they can scratch the surface, which may result in shattering of the glass.
☒	Appliances are not intended to be operated by means of an external timer or separate remote-control system.

This product is a Group 2 Class B ISM equipment. The definition of group 2 which contains all ISM equipment in which radio-frequency energy is intentionally generated and/or used in the form of electromagnetic radiation for the treatment of material, and

EDM and arc welding equipment. For Class B equipment is equipment suitable for use in domestic establishments and in establishments directly connected to a low voltage power supply network which supplies buildings used for domestic purposes.

### **INSTALLING YOUR MICROWAVE OVEN**

Place the oven on a flat level surface 85 cm above the floor. The surface should be strong enough to safely bear the weight of the oven.

1. When you install your oven, make sure there is adequate ventilation for your oven by leaving at least 10 cm (4 inches) of space behind and, on the sides of the oven and 20 cm (8 inches) of space above.
2. Remove all packing materials inside the oven.
3. Install the roller ring and turntable. Check that the turntable rotates freely. (Turntable type model only)
4. This microwave oven has to be positioned so that plug is accessible.

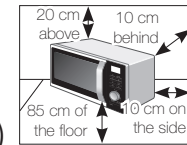

- ☐ If the supply cord is damaged, it must be replaced by the manufacturer, its service agent or similarly qualified persons in order to avoid a hazard.  
For your personal safety, plug the cable into a proper AC earthed socket.
- ☐ Do not install the microwave oven in hot or damp surroundings like next to a traditional oven or radiator. The power supply specifications of the oven must be respected and any extension cable used must be of the same standard as the power cable supplied with the oven. Wipe the interior and the door seal with a damp cloth before using your microwave oven for the first time.

## **CLEANING YOUR MICROWAVE OVEN**

The following parts of your microwave oven should be cleaned regularly to prevent grease and food particles from building up:

- Inside and outside surfaces
  - Door and door seals
  - Turntable and Roller rings  
(Turntable type model only)
- ☐ **ALWAYS** ensure that the door seals are clean and the door closes properly.

- ☐ Failure to maintain the oven in a clean condition could lead to deterioration of the surface that could adversely affect the life of the appliance and possibly result in a hazardous situation.

1. Clean the outside surfaces with a soft cloth and warm, soapy water. Rinse and dry.
  2. Remove any splashes or stains on the inside surfaces of oven with a soapy cloth. Rinse and dry.
  3. To loosen hardened food particles and remove smells, place a cup of diluted lemon juice in the oven and heat for ten minutes at maximum power.
  4. Wash the dishwasher-safe plate whenever necessary.
- ☐ **DO NOT** spill water in the vents. **NEVER** use any abrasive products or chemical solvents. Take particular care when cleaning the door seals to ensure that no particles:
- Accumulate
  - Prevent the door from closing correctly

- ✎ **Clean** the microwave oven cavity right after each use with a mild detergent solution, but let the microwave oven cool down before cleaning in order to avoid injury.

When cleaning the upper part inside the cavity, it will be convenient to turn heater downward by 45 ° and clean it. (Swing heater model only)

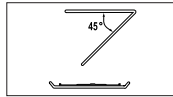

## STORING AND REPAIRING YOUR MICROWAVE OVEN

A few simple precautions should be taken when storing or having your microwave oven serviced.

The oven must not be used if the door or door seals are damaged:

- Broken hinge
- Deteriorated seals
- Distorted or bent oven casing

Only a qualified microwave service technician should perform repair

- ✎ **NEVER** remove the outer casing from the oven. If the oven is faulty and needs servicing or you are in doubt about its condition:

- Unplug it from the wall socket
- Contact the nearest after-sales service centre

- ✎ If you wish to store your oven away temporarily, choose a dry, dustfree place. **Reason :** Dust and damp may adversely affect the working parts in the oven.

- ✎ This microwave oven is not intended for commercial use.

- ✎ The Light bulb should not be replaced in person for safety reasons. Please contact nearest authorised Samsung customer care, to arrange for a qualified engineer to replace the bulb.











⚠ WARNING		🔥	⚡	🚰	👤
✎	Only qualified staff should be allowed to modify or repair the appliance.	✓	✓	✓	✓
✎	Do not heat liquids and other food in sealed containers for microwave function.	✓	✓	✓	✓
✎	For your safety, do not use high-pressure water cleaners or steam jet cleaners.	✓	✓	✓	✓
✎	Do not install this appliance; near heater, inflammable material; in a humid, oily or dusty location, in a location exposed to direct sunlight and water or where gas may leak; on un level ground.	✓	✓	✓	✓
🔌	This appliance must be properly grounded in accordance with local and national codes.	✓	✓	✓	✓





English - 8

<input checked="" type="checkbox"/>	Remove all foreign substances such as dust or water from the power plug terminals and contact points using a dry cloth on a regular basis.	✓	✓	✓	✓
<input type="checkbox"/>	Do not pull or excessively bend or place heavy object on the power cord.	✓	✓	✓	✓
<input checked="" type="checkbox"/>	In the event of a gas leak (such as propane gas, LP gas, etc.), ventilate immediately without touching the power plug.	✓	✓	✓	✓
<input type="checkbox"/>	Do not touch the power plug with wet hands.	✓	✓	✓	✓
<input type="checkbox"/>	Do not turn the appliance off by unplugging the power plug while an operation is in progress.	✓	✓	✓	✓
<input type="checkbox"/>	Do not insert fingers or foreign substances. If any foreign substance such as water has entered the appliance, unplug the power plug and contact your nearest service centre.	✓	✓	✓	✓
<input type="checkbox"/>	Do not apply excessive pressure or impact to the appliance.	✓	✓	✓	✓
<input type="checkbox"/>	Do not place the oven over a fragile object such as a sink or glass object.	✓	✓		
<input type="checkbox"/>	Do not use benzene, thinner, alcohol, steam cleaner or high pressure cleaner to clean the appliance.	✓	✓	✓	✓
<input type="checkbox"/>	Ensure that the power voltage, frequency and current are the same as those of the product specifications.	✓	✓		✓
<input type="checkbox"/>	Plug the power plug into the wall socket firmly. Do not use a multiple plug adapter, an extension cord or an electric transformer.	✓	✓	✓	
<input type="checkbox"/>	Do not hook the power cord on a metal object, insert the power cord between the objects or behind the oven.	✓	✓	✓	

<input type="checkbox"/>	Do not use a damaged power plug, damaged power cord or loose wall socket. When the power plug or power cord is damaged, contact your nearest service centre.	✓	✓	✓	✓
<input type="checkbox"/>	Do not pour or directly spray water onto the oven.	✓	✓		
<input type="checkbox"/>	Do not place objects on the oven, inside or on the door of the oven.	✓	✓	✓	
<input type="checkbox"/>	Do not spray volatile material such as insecticide onto the surface of the oven.	✓	✓		
<input type="checkbox"/>	Do not store flammable materials in the oven. Take special care when heating dishes or drinks that contain alcohol as alcohol vapours may contact a hot part of the oven.	✓		✓	✓
<input checked="" type="checkbox"/>	Keep children away from the door when opening or closing it as they may bump themselves on the door or catch their fingers in the door.	✓	✓	✓	✓
<input checked="" type="checkbox"/>	<b>WARNING:</b> Microwave heating of beverages can result in delayed eruptive boiling, therefore care must be taken when handling the container; To prevent this situation ALWAYS allow a standing time of at least 20 seconds after the oven has been switched off so that the temperature can equalize. Stir during heating, if necessary, and ALWAYS stir after heating. In the event of scalding, follow these FIRST AID instructions: <ul style="list-style-type: none"> <li>Immerse the scalded area in cold water for at least 10 minutes.</li> <li>Cover with a clean, dry dressing.</li> <li>Do not apply any creams, oils or lotions.</li> </ul>	✓	✓	✓	✓
<input type="checkbox"/>	Do not put the tray or rack in water shortly after cooking because it may cause breakage or damage of the tray or rack.				✓

	Do not operate the microwave oven for deep fat frying because the oil temperature cannot be controlled. This could result in a sudden boil over of the hot liquid.	✓			✓
---	--	---	--	--	---

<b>CAUTION</b>					
	Only use utensils that are suitable for use in microwave ovens; DO NOT use any metallic containers, Dinnerware with gold or silver trimmings, Skewers, forks, etc. Remove wire twist ties from paper or plastic bags. Reason: Electric arcing or sparking may occur and may damage the oven.	✓		✓	✓
	Do not use your microwave oven to dry papers or clothes.	✓		✓	✓
	Use shorter times for smaller amounts of food to prevent overheating and burning food.	✓		✓	✓
	Do not immerse the power cable or power plug in water and keep the power cable away from heat.	✓	✓		
	Eggs in their shell and whole hard-boiled eggs should not be heated in microwave ovens since they may explode, even after microwave heating has ended; Also do not heat airtight or vacuum-sealed bottles, jars, containers, nuts in shells, tomatoes etc.			✓	✓
	Do not cover the ventilation slots with cloth or paper. They may catch fire as hot air escapes from the oven. The oven may also overheat and switch itself off automatically, and will remain off until it cools sufficiently.	✓		✓	
	Always use oven mitts when removing a dish from the oven to avoid unintentional burns.			✓	

	Stir liquids halfway during heating or after heating ends and allow the liquid stand at least 20 seconds after heating to prevent eruptive boiling.			✓	
	Stand at arms length from the oven when opening the door to avoid getting scalded by escaping hot air or steam.			✓	
	Do not operate the microwave oven when it is empty. The microwave oven will automatically shut down for 30 minutes for safety purposes. We recommend placing a glass of water inside the oven at all times to absorb microwave energy in case the microwave oven is started accidentally.	✓			✓
	Install the oven in compliance with the clearances stated in this manual. (See installing your microwave oven.)	✓		✓	
	Take care when connecting other electrical appliances to sockets near the oven.	✓	✓	✓	

### PRECAUTIONS TO AVOID POSSIBLE EXPOSURE TO EXCESSIVE MICROWAVE ENERGY.(MICROWAVE FUNCTION ONLY)

Failure to observe the following safety precautions may result in harmful exposure to microwave energy.

- (a) Under no circumstances should any attempt be made to operate the oven with the door open or to tamper with the safety interlocks (door latches) or to insert anything into the safety interlock holes.
- (b) Do NOT place any object between the oven door and front face or allow food or cleaner residues to accumulate on sealing surfaces. Ensure that the door and door sealing surfaces are kept clean by wiping after use first with a damp cloth and then with a soft dry cloth.
- (c) Do NOT operate the oven if it is damaged until it has been repaired by a qualified microwave service technician trained by the manufacturer. It is particularly important that the oven door closes properly and that there is no damage to the:
  - (1) door (bent)
  - (2) door hinges (broken or loose)
  - (3) door seals and sealing surfaces
- (d) The oven should not be adjusted or repaired by anyone other than a properly qualified microwave service technician trained by the manufacturer.

Samsung will charge a repair fee for replacing an accessory or repairing a cosmetic defect if the damage to the unit and/or damage to or loss of the accessory was caused by the customer. Items this stipulation covers include:

- (a) A Dented, Scratched, or Broken Door, Handle, Out-Panel, or Control Panel.
- (b) A Broken or missing Tray, Guide Roller, Coupler, or Wire Rack.
- Use this appliance only for its intended purpose as described in this instruction manual. Warnings and Important Safety Instructions in this manual do not cover all possible conditions and situations that may occur. It is your responsibility to use common sense, caution, and care when installing, maintaining, and operating your appliance.
- Because these following operating instructions cover various models, the characteristics of your microwave oven may differ slightly from those described in this manual and not all warning signs may be applicable. If you have any questions or concerns, contact your nearest service centre or find help and information online at [www.samsung.com](http://www.samsung.com).
- This microwave oven is supposed for heating food. It is intended for domestic home-use only. Do not heat any type of textiles or cushions filled with grains, which could cause burns and fire. The manufacturer cannot be held liable for damage caused by improper or incorrect use of the appliance.
- Failure to maintain the oven in a clean condition could lead to deterioration of the surface that could adversely affect the life of the appliance and possible result in a hazardous situation.



### **CORRECT DISPOSAL OF THIS PRODUCT (WASTE ELECTRICAL & ELECTRONIC EQUIPMENT)**

#### **(Applicable in countries with separate collection systems)**

This marking on the product, accessories or literature indicates that the product and its electronic accessories (e.g. charger, headset, USB cable) should not be disposed of with other household waste at the end of their working life. To prevent possible harm to the environment or human health from uncontrolled waste disposal, please separate these items from other types of waste and recycle them responsibly to promote the sustainable reuse of material resources.

Household users should contact either the retailer where they purchased this product, or their local government office, for details of where and how they can take these items for environmentally safe recycling.

Business users should contact their supplier and check the terms and conditions of the purchase contract. This product and its electronic accessories should not be mixed with other commercial wastes for disposal.

## quick look-up guide

### If you want to cook some food.

	<b>1.</b> Place the food in the oven. Press <b>Microwave</b> button to start cooking.
	<b>2.</b> Turn <b>Dial Knob</b> to desired until the appropriate power level is displayed. At that time, press the <b>Dial Knob</b> to set the power level.
	<b>3.</b> Set the cooking time by turning the <b>Dial Knob</b> .
	<b>4.</b> Press the <b>START/+30s</b> button. <b>Result:</b> Cooking starts. The oven beeps 4 times when cooking is over.



### If you want to auto Power defrost some food.

	<b>1.</b> Place the frozen food in the oven. Press the <b>Power Defrost</b> button.
	<b>2.</b> Set the cooking category by turning the <b>Dial Knob</b> . Press <b>Dial Knob</b> to set desired.
	<b>3.</b> Select the weight by turning the <b>Dial Knob</b> as required.
	<b>4.</b> Press the <b>START/+30s</b> button.

**If you want to add extra 30 seconds.**

 START/+30сек <input type="text"/>	Leave the food in the oven. Press <b>START/+30s</b> one or more times for each extra 30 seconds that you wish to add.
---	--

**If you want to grill some food.**

 Гриль <input type="text"/>	<b>1.</b> Press the <b>Grill</b> button.
	<b>2.</b> Select the cooking time by turning the <b>Dial Knob</b> as required.
 START/+30сек <input type="text"/>	<b>3.</b> Press the <b>START/+30s</b> button.

## oven features

### OVEN

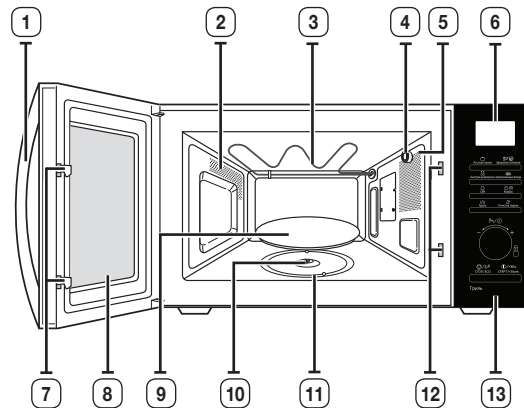

- |                      |                            |
|----------------------|----------------------------|
| 1. DOOR HANDLE       | 7. DOOR                    |
| 2. VENTILATION HOLES | 8. TURNTABLE               |
| 3. GRILL             | 9. COUPLER                 |
| 4. WATER BOWL HOLDER | 10. ROLLER RING            |
| 4. LIGHT             | 11. SAFETY INTERLOCK HOLES |
| 5. DISPLAY           | 12. CONTROL PANEL          |
| 6. DOOR LATCHES      |                            |





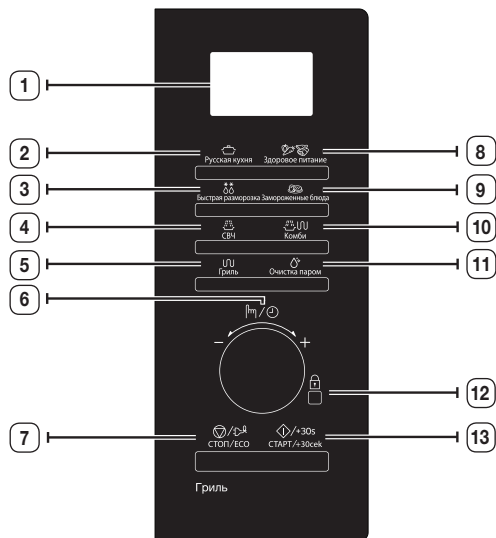

## CONTROL PANEL

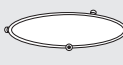
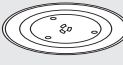

- |  |                           |
|--|---------------------------|
| 1. DISPLAY                                   | 7. STOP/ECO BUTTON        |
| 2. RUSSIAN CUISINE BUTTON                    | 8. HEALTHY COOKING BUTTON |
| 3. POWER DEFROST BUTTON                      | 9. MY PLATE BUTTON        |
| 4. MICROWAVE BUTTON                          | 10. COMBI BUTTON          |
| 5. GRILL BUTTON                              | 11. STEAM CLEAN BUTTON    |
| 6. DIAL KNOB<br>(WEIGHT/SERVING/TIME/SELECT) | 12. CHILD LOCK BUTTON     |
|  | 13. START/+30s BUTTON     |

## ACCESSORIES

Depending on the model that you have purchased, you are supplied with several accessories that can be used in a variety of ways.

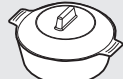
	<p><b>1. Roller ring</b>, to be placed in the centre of the oven.  <b>Purpose:</b> The roller ring supports the turntable.</p>
	<p><b>2. Turntable</b>, to be placed on the roller ring with the centre fitting to the coupler.  <b>Purpose:</b> The turntable serves as the main cooking surface; it can be easily removed for cleaning.</p>
	<p><b>3. Grill rack</b>, to be placed on the turntable.  <b>Purpose:</b> The metal rack can be used in grill and combination cooking.</p>
	<p><b>4. Crusty plate</b>, see page 26 to 27.          (Only MG23H3115N*, MG23H3115X* models)  <b>Purpose:</b> The crusty plate is used to brown food better in the microwave or grill combination cooking modes. It helps keep pastry and pizza dough crisp.</p>
	<p><b>5. Clean water bowl</b>, see page 17.          (Only MG23H3115B*, MG23H3115N*, MG23H3115P*, MG23H3115X* models)  <b>Purpose:</b> The water bowl can be used to clean.</p>
	<p><b>6. Steam cooker</b>, see page 24 to 25.          (Only MG23H3115P*, MG23H3115X* models)  <b>Purpose:</b> The plastic steam cooker when using power steam function.</p>

 **DO NOT** operate the microwave oven without the roller ring and turntable.

 **DO NOT** operate the **GRILL** and **COMBI** mode with steam cooker.

Operation Mode	MW	GRILL	COMBI
 (Steam cooker)	O	X	X

## oven use

### HOW A MICROWAVE OVEN WORKS

Microwaves are high-frequency electromagnetic waves; the energy released enables food to be cooked or reheated without the foods form or colour changing.

You can use your microwave oven to:

- Defrost (manual & auto)
- Cook
- Reheat

Cooking Principle.

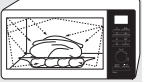
	1. The microwaves generated by the magnetron are distributed uniformly as the food rotates on the turntable. The food is thus cooked evenly.
	2. The microwaves are absorbed by the food up to a depth of about 1 inch (2.5 cm). Cooking then continues as the heat is dissipated within the food.
	3. Cooking times vary according to the recipient used and the properties of the food: <ul style="list-style-type: none"> <li>• Quantity and density</li> <li>• Water content</li> <li>• Initial temperature (refrigerated or not)</li> </ul>

 As the centre of the food is cooked by heat dissipation, cooking continues even when you have taken the food out of the oven. Standing times specified in recipes

and in this booklet must therefore be respected to ensure:

- Even cooking of the food right to the centre.
- The same temperature throughout the food.

### CHECKING THAT YOUR OVEN IS OPERATING CORRECTLY

The following simple procedure enables you to check that your oven is working correctly at all times.

Open the oven door by pulling the handle on the right side of the door. Place a glass of water on the turntable. Then, close the door.

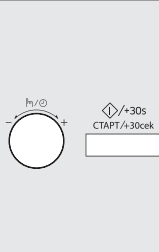
	1. Press the <b>Microwave</b> button. <b>Result:</b> The 800 W (maximum cooking power) indications are displayed
	2. After press the <b>Dial Knob</b> (800 W), set the time 4 to 5 minutes by turning the <b>Dial Knob</b> and press the <b>START/+30s</b> button. <b>Result:</b> The oven light comes on and the turntable starts rotating. <ol style="list-style-type: none"> <li>1) Cooking starts and when it has finished the oven beeps 4 times.</li> <li>2) The end reminder signal will beep 3 times (once every minute).</li> <li>3) The current time is displayed again.</li> </ol>

 The oven must be plugged into an appropriate wall socket. The turntable must be in position in the oven. If a power level other than the maximum is used, the water takes longer to boil.

## SETTING THE TIME

Your microwave oven has an inbuilt clock. When power is supplied, "0", "88:88" or "12:00" is automatically displayed on the display.

Please set the current time. The time can be displayed in either the 24-hour or 12-hour notation. You must set the clock:

- When you first install your microwave oven
- After a power failure

 Do not forget to reset the clock when you switch to and from summer and winter time.





	<p><b>1.</b> Press the <b>Dial Knob</b>. <b>To display the time in the...</b> 24-hour notation. 12-hour notation.</p>
	<p><b>2.</b> Turn the <b>Dial Knob</b> to set time display type. (24H or 12H). At that time, press the <b>Dial Knob</b> to select the type of time.</p>
	<p><b>3.</b> Turn the <b>Dial Knob</b> to set the hour. At that time, press the <b>Dial Knob</b> to set the hour.</p>
	<p><b>4.</b> Turn the <b>Dial Knob</b> to set the minute.</p>
	<p><b>5.</b> Press the <b>Dial Knob</b> to complete the setup.</p>

## COOKING/REHEATING

The following procedure explains how to cook or reheat food.

ALWAYS check your cooking settings before leaving the oven unattended.

First, place the food in the centre of the turntable. Then, close the door.

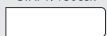
 CB4 	<p><b>1.</b> Press the <b>Microwave</b> button. <b>Result:</b> The 800 W (maximum cooking power) indications are displayed:</p>
	<p><b>2.</b> Turn <b>Dial Knob</b> to desired until the appropriate power level is displayed. At that time, press the <b>Dial Knob</b> to set the power level.</p>
	<p><b>3.</b> Set the cooking time by turning the <b>Dial Knob</b>. <b>Result:</b> The cooking time is displayed.</p>
 CTAPT/+30cek 	<p><b>4.</b> Press the <b>START/+30s</b> button. <b>Result:</b> The oven light comes on and the turntable starts rotating.</p> <ol style="list-style-type: none"> <li>1) Cooking starts and when it has finished the oven beeps 4 times.</li> <li>2) The end reminder signal will beep 3 times (once every minute).</li> <li>3) The current time is displayed again.</li> </ol>

 **Never** switch the microwave oven on when it is empty.

 If you wish to heat a dish for a short period of time at maximum power (800 W), simply press the **START/+30s** button once for each 30 seconds of cooking time. The oven starts immediately.

## POWER LEVELS



You can choose among the power levels below.

Power level	Output	
	MWO	GRILL
HIGH	800 W	-
MEDIUM HIGH	600 W	-
MEDIUM	450 W	-
MEDIUM LOW	300 W	-
DEFROST	180 W	-
LOW/KEEP WARM	100 W	-
GRILL	-	1100 W
COMBI I	600 W	1100 W
COMBI II	450 W	1100 W
COMBI III	300 W	1100 W

 If you select higher power level, the cooking time must be decreased.



 If you select lower power level, the cooking time must be increased.

## ADJUSTING THE COOKING TIME

 <p>START/+30s СТАРТ/4-30сек</p>	You can increase the cooking time by pressing the <b>START/+30s</b> button once for each 30 seconds to be added.
	You can also increase the cooking time by turning <b>Dial Knob</b> once for each 10 sec to be added.

## STOPPING THE COOKING

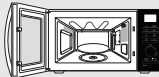
You can stop cooking at any time to check the food.

	<p>1. To stop temporarily;</p> <p>1) Open the door. <b>Result:</b> Cooking stops. To resume cooking, close the door and press <b>START/+30s</b> button again.</p> <p>2) Press the <b>STOP/ECO</b> button. <b>Result:</b> Cooking stops. To resume cooking, press <b>START/+30s</b> button again.</p>
	<p>2. To stop completely;</p> <p>Press the <b>STOP/ECO</b> button. <b>Result:</b> The cooking stops. If you wish to cancel the cooking settings, press the <b>STOP/ECO</b> button again.</p>

 You can also cancel any setting before starting by simply pressing **STOP/ECO** button.

## SETTING THE ENERGY SAVE MODE

The oven has an energy save mode. This facility saves electricity when the oven is not in use. Normal condition is standby mode and show clock when not using.

	<ul style="list-style-type: none"> <li>Press the <b>STOP/ECO</b> button. <b>Result:</b> Display off.</li> <li>To remove energy save mode, open the door or press the <b>STOP/ECO</b> button and then display shows current time. The oven is ready for use.</li> </ul>
--	--

### Auto energy saving function

If you do not select any function when appliance is in the middle of setting or operating with temporary stop condition, function is canceled and clock will be displayed after 25 minutes.



Oven Lamp will be turned off after 5 minutes with door open condition.

## USING THE STEAM CLEANING (ONLY MG23H3115B\*, MG23H3115N\*, MG23H3115P\*, MG23H3115X\* MODELS)

The steam provided by steam clean system will soak the cavity surface. After using steam clean function, you can easily clean the cavity of oven.

 Use this function only after the oven has completely cooled.  
(Room temperature)

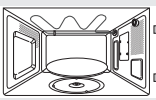
 Use normal water only, and no distilled water.

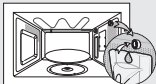
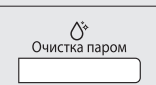
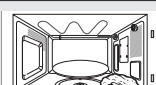
	1. Open the Door.
	2. Fill with water following guide line (water level) outside the water bowl. (The line is about 50 ml.)
	3. Insert water bowl into upper water bowl holder on the right wall of cooking chamber. At that time close the door.
	4. Press the <b>Steam Clean</b> button. It can be seen <b>MISTY</b> during steam cleaning, but it is not a defect <b>BUT STEAM SHIELDS THE light INSIDE.</b>
	5. Open the door and please clean cavity of oven with dried dishtowel. Remove the turntable and only under rack with kitchen paper.



 **WARNING** Water Bowl only can be use during “**Steam Clean**” mode.  
When cooking non-liquid items, remove water bowl because It will damage and cause fire to the microwave oven.

 More than 50 ml water may cause a leak at the back through the hole. Ensure that it is not more than 50 ml.

## USING THE RUSSIA CUISINE FEATURES

The Auto Russian Cuisine features has 41 pre-programmed cooking times. You do not need to set either the cooking times or the power level.

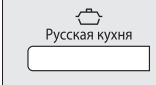
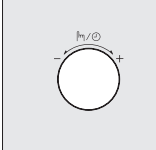
First, place the food in the centre of the turntable and close the door.

	1. Press the <b>Russian Cuisine</b> button.
	2. Select the category that you are cooking by turning the <b>Dial Knob</b> , then press the <b>Dial Knob</b> to set. And then, select the food that you are cooking by turning the <b>Dial Knob</b> . Refer to the table on the following page for a description of the various pre-programmed settings.
	3. Press the <b>START/+30s</b> button. <b>Result:</b> Cooking starts. When it has finished. 1) The oven beeps 4 times. 2) The end reminder signal will beep 3 times (once every minute). 3) The current time is displayed again.

 Use only recipients that are microwave-safe.

## 1. Breakfast

Code/Food	Ingredients / Instructions
<b>1-1 Porridge</b>	Dry Russian porridge (Hercules) - 50 g, Sugar - 5 g, Salt - 0.5 g, Boiling water - 200 ml, Cold Milk - 150 ml
	Put into a big bowl shaped plate dry porridge, sugar, salt. Add boiling water, milk, mix well. Start cooking.
<b>1-2 Buckwheat</b>	Buckwheat - 100 g, Salt - 2 g, Boiling water - 300 ml
	Put into a bowl shaped plate buckwheat, salt. Add boiling water, mix well. Start cooking.
<b>1-3 Cheese Toast</b>	Toast bread - 2 pc (26 to 28 g/pc), Cheese - 2 pc (20 g/pc)
	Put on two toasts to the high rack. Start cooking. As soon as oven beeps, upside down toasts and put on cheese to the toasts. And continue cooking process.
<b>1-4 Poached Egg</b>	Egg - 1 pc, Water - 150 ml, Russian vinegar 9% - 10 to 15 ml
	Put in bowl with water & vinegar into microwave oven. Bring water to a boil. As soon as oven beeps, put out the bowl with boiling water & vinegar. To make a funnel by a fork into the bowl, drop inside egg without shell. Continue cooking process.
<b>1-5 Bread with Canned Salmon and Hot Mayonnaise</b>	Bread - 2 pc (22 g/pc), Canned Salmon - 60 g (30 g/pc), Mayonnaise - 36 g (18 g/pc), Chives (chopped) - 2 to 5 g
	Put on two bread pieces to the high rack. Start cooking. As soon as oven beeps, take away bread. And upside down bread and put on canned salmon and mayonnaise to bread. Continue cooking process. Decorate chopped chives on top.
<b>1-6 Sausages with Canned Pea</b>	Sausages - 2 pc (50 g/pc), Butter - 5 g, Canned pea - 135 g (dry weight)
	Put into a plate pricked sausages without plastic cover, add butter a side. Put on the top of butter canned pea. Start cooking.
<b>1-7 Omelette</b>	Egg - 3 pc, Milk - 30 ml, Salt - 2 g
	Whisk the egg with milk and salt, pour out egg to a plate. Start cooking.

Code/Food	Ingredients / Instructions
<b>1-8 Syrniki</b>	Custard cheese - 90~100 g, Wheat - 10 g, Sugar (vanilla infused sugar) - 10 g, Salt - 0.5 g, Egg - ¼ pc, Butter - 5~10 g (for greasing), Fluor - 30 g
	All ingredients except butter mix well. Make two tablet forms. Grease on butter to the tablet forms. Put it on wax paper and on high rack. Start cooking. As soon as oven beeps, upside down tablet forms and continue cooking process.
<b>1-9 Keks</b>	Sugar - 45 g, Vanilla infused sugar - 5 g, Butter - 40 g, Egg - 0.5 pc, Milk - 30 ml, Baking powder - 3 g, Wheat - 100 g
	Mix well sugar, infused sugar and butter. Add beaten egg. Add all next ingredients. Put it into a buttered bowl. Start cooking. Give it cold before removing out the bowl.
<b>1-10 Lemon Shortbread Bolls</b>	Wheat - 100 g, Butter - 50 g, Sugar - 40 g, Egg yolk - 0.5 pc, Warm water - 1 tbs, Lemon zests, For topping: Egg yolk - 1 pc, Ice sugar - 3~5 g
	Mix well all ingredients. Make five balls. Put it on wax paper. Put it on turntable. Start cooking. As soon as oven beeps, grease egg yolk on the balls top, sprinkle with ice sugar and continue cooking process. Leave it to cold.

## 2. Lunch

Code/Food	Ingredients / Instructions
<b>2-1 Borsch</b>	(1) Beetroot graded - 50 g, Cabbage julienned - 20 g, Carrot graded - 15 g, Onion julienned - 10 g, Tomato paste - 15 g, Sugar - 5 g (2) Beef stock or water with dry concentrate - 650 ml, Bay leaf - 1 pc Russian vinegar 9 % - 5 ml if you like. Garlic, greenary and sour cream for serving Put all ingredients(1) into a big bowl, add hot stock and start cooking. As soon as oven beeps, add bay leaf. Mix well and continue cooking process.
<b>2-2 Schi</b>	(1) Cabbage julienned - 45 g, Carrot graded - 15 g, Onion julienned - 10 g, Potato batons - 25 g, Tomato paste - 10 g, Beef stock or water with dry concentrate - 400 ml (2) Beef stock or water with dry concentrate - 100 ml, Bay leaf - 1 pc. Greenary for serving Put all ingredients(1) into a big bowl, add boiling stock. Start cooking. As soon as oven beeps, mix well, add stock, bay leaf(2). And continue cooking process.
<b>2-3 Meat Solyanka</b>	(1) Onion julienned - 45 g, Beef stock or water with dry concentrate - 350 ml (2) Capers - 7 g, Salted cucumber graded - 50 g, Tomato paste - 30 g, Black Olives - 16 g, Liquid of Black Olives - 20 ml, Bay leaf - 1 pc, Meat assorted - 30 g, Beef stock or water with dry concentrate - 350 ml Put onion into a big bowl, add boiling stock(1). Start cooking. As soon as oven beeps, add all next ingredients(2). Mix well, add stock, bay leaf and continue cooking process.
<b>2-4 Vegetable Soup</b>	Frozen vegetables - 150 g, Vegetable stock or water with dry concentrate - 300 ml. Greenary for serving Put all ingredients into a big bowl, add boiling stock. Start cooking.

Code/Food	Ingredients / Instructions
<b>2-5 Chicken Noodle Soup</b>	Vermicelli - 15 g, Chicken filet - 50 g, Carrot graded - 15 g, Onion julienned - 10 g, Chicken stock or water with dry concentrate - 440 ml. Greenary for serving Put vermicelli into a big bowl, add boiling stock. Cut fillet into slices and add with all other ingredients. Mix well and start cooking.
<b>2-6 Cutlets</b>	(1) White bread - 10 g, Milk - 15 ml (2) Pork & beef minced meat - 120 g, Salt - 2 g, Black pepper - 1 g (3) Bread crumbs - 5 g Drop milk to bread(1). Mix it well with minced meat. Add spices(2). Form it in two balls, cover with bread crumbs(3). Put it on a plate on the high rack. Start cooking.
<b>2-7 Grilled Salmon Steak</b>	Salmon steak with bone and skin - 200 to 250 g, Salt - 1 g, Lemon - 15 g (squeeze juice), Oil - 5 g Salmon steak season, oil. Put it on a plate. Put the plate on the low rack and start cooking.
<b>2-8 Pork Neck with Mustard Sauce</b>	(1) Pork neck - 150 g, Carrot graded - 20 g, Onion julienned - 20 g, Chicken stock or water with dry concentrate - 100 ml (2) Mix for sauce: Wheat - 5 g, Dijon mustard - 20 g, Sour Cream - 30 g, Water - 50 ml Cut meat into batons, prepare vegetables.add chicken stock.(1) Pour into a plate. Mix well and start cooking. Prepare all ingredients for the mix for sauce(2). As soon as oven beeps, Pour the mix into stock with meat, mix it and continue cooking process.
<b>2-9 Pelmeni</b>	Frozen Pelmeni - 15 pc (10 to 12 g one piece), Chicken stock or water with dry concentrate - 400 ml, Whole black pepper - 3 to 5 pc, Bay leaf - 1 pc. Put all ingredients into a big bowl plate, add boiling stock. Cover with a plastic bowl shaped lid. Start cooking.
<b>2-10 Dry Fruit Compote</b>	Dry apricot - 25 g, Prune - 20 g, Dry apple - 15 g, Sugar - 10 g, Lemon acid - 2 dash, Boiling water - 600 ml Put all ingredients into a big bowl, add boiling water. Start cooking.

### 3. Dinner

Code/Food	Ingredients / Instructions
<b>3-1 Meatloaf with Hard Boiled Egg</b>	Minced meat (beef & pork) - 150 g, Hardboiled egg - 1 pc, Salt - 2 g, Black pepper powder - 0.5 g
	Add spice into meat and mix hard by hand. Roll meat into round form. Put in the center of meat round the egg. Cover the egg by meat from all side. Form it in arc form. Put it on a plate. Put the plate on the turntable. Start cooking.
<b>3-2 Lazy Cabbage Rolls</b>	(1) Meat ovals (a) Minced meat (beef & pork) - 120 g, Cooked regular rice - 25 g, Cabbage chopped - 25 g, Salt - 1 to 2 g, Black pepper powder - 0.5 g (b) Onion julienned - 30 g, Beef stock or water with dry concentrate - 100 ml (2) Mix for sauce: Wheat - 5 g, Tomato paste - 10 g, Sour Cream - 30 g, Water - 50 ml
	Add vegetables and spice into meat and mix hard by hand(a). Form it in two ovals. Put onion into a bowl shaped plate. Put meat ovals on it, add the stock(b). Put the plate on the high rack. Start cooking. Prepare all ingredients for the Mix for sauce(2). As soon as oven beeps, pour the mix into stock with meat ovals. Upside down it and continue cooking process.
<b>3-3 Meat Balls in Tomato Sauce</b>	(1) Meat balls (2) White bread - 30 g, Milk - 35 ml, Minced meat (beef & pork) - 130 g, Salt - 1 to 2 g, Black pepper powder - 0.5 g (3) Onion julienned - 15 g, Carrot julienned - 30 g, Beef stock or water with dry concentrate - 100 ml (4) Mix for sauce: Wheat - 5 g, Tomato paste - 20 g, Water - 75 ml
	Put bread into milk. Add it inside minced meat. Season it and mix hard by hand(2). Form it in two balls. Put onion and carrot into a bowl shaped plate(3). Put meat balls on it, add the stock. Put the plate on the high rack. Start cooking. Prepare all ingredients for the Mix for sauce(4). As soon as oven beeps, pour the mix into stock with meat balls. Upside down it and continue cooking process.

Code/Food	Ingredients / Instructions
<b>3-4 Chicken Legs with Prunes</b>	Onion julienned - 15 g, Carrot julienned - 20 g, Chicken legs - 2 pc (160 to 180 g), Prunes - 5 to 7 pc (50 g), Chicken stock or water with dry concentrate - 150 ml
	Put onion and carrot into a plate. Put chicken legs on it, add prunes and the stock. Put the plate in microwave oven. Start cooking. As soon as oven beeps, upside down it and continue cooking process.
<b>3-5 Turkey Steamed with Vegetables</b>	Turkey filet batons - 150 g, Zucchini julienned - 50 g, Onion julienned - 15 g, Carrot julienned - 20 g, Chicken stock or water with dry concentrate - 100 ml
	Put all ingredients into a bowl shaped plate add boiling stock. Start cooking. As soon as oven beeps, upside down it, mix veg and continue cooking process.
<b>3-6 Baked Potatoes</b>	Big size potato (160 - 200 g) - 1 to 2 pc
	Peel potatoes, to put it to the not deep dish without water and cover with food film. Put in microwave. Start cooking. Put butter or sour cream or cheese or something else before serving.
<b>3-7 Ratatouille</b>	Zucchini diced - 100 g, Carrot diced - 60 g, Bell pepper diced - 75 g, Onion diced - 45 g, Garlic chopped - 6 g, Tomato paste - 10 g, Oregano and Basil - to taste, Vegetables stock or water with dry concentrate - 150 ml
	Put all ingredients into a bowl shaped plate. (Add oregano & basil). Mix well. Start cooking.
<b>3-8 Buckwheat Pudding</b>	(a) Custard cheese 9 % - 120 to 140 g, Sugar - 10 to 15 g, Salt - 0.5 g, Egg - ½ pc, Ready cooked buckwheat - 140 g (b) Butter - 5 g, Bread crumbs - 1 to 2 g (c) Sour cream - 30 g
	Mix all ingredients(a). Put into buttered and covered with bread crumbs bowl shaped plate(b). Cover sour cream on top(c). Start cooking.



Code/Food	Ingredients / Instructions
<b>3-9 Russian Old Style Fish</b>	(1) Beetroot julienned - 30 g, Carrot julienned - 30 g, Onion julienned - 15 g, Fish/Chicken stock or water with dry concentrate - 200 ml (2) Mix for sauce: Wheat - 10 g, Tomato paste - 10 g, Sour cream - 30 g, Water - 50 ml (3) Carp or pike perch filet - 150 g, Bay leaf - 1 pc
	Put all ingredients into a bowl shaped plate add boiling stock.(1) Start cooking. As soon as oven beep, stir in mix for sauce with veg and stock (2). Add fish and bay leaf (3). Continue cooking process.
	(1) Champignons - 30 g, Pike perch filet - 150 g, Oil - 5 g (2) Sour cream - 30 g (2 x 15 g) (3) Baked potato round cut - 2 pc per 60 to 70 g, Salt - 5 g, White pepper powder - 0.5 g, Graded cheese - 25 g
<b>3-10 Moscow Style Fish</b>	Put mushrooms on a plate fish aside. Drop oil on it(1). Start cooking. As soon as oven beeps, put a half of sour cream on a ceramic plate (in the center) (2). Put cooked mushrooms on it. Put Fish on it. Season it. Put around fish cut potato. Put on potato cheese(3). Continue cooking process.
<b>3-11 Frozen Pizza</b>	Frozen pizza - 350 g
	Put frozen pizza with wax paper on the grill rack. Start cooking.

#### 4. Special Occasions

Code/Food	Ingredients / Instructions
<b>4-1 Bell Pepper Stuffed with Meat</b>	(1) Bell pepper - 2 pc per 80 g, Minced meat (beef & pork) - 150 to 190 g (divide to two part), Cooked regular rice - 10 to 20 g, Salt - 5 g, Black pepper powder - 0.5 g, Beef stock or water with dry concentrate - 200 ml (2) Mix for sauce: Wheat - 5 g, Tomato paste - 20 g, Water - 50 ml
	Add rice inside minced meat. Season it and mix hard by hand. Remove the center and seeds from the pepper. Stuff pepper by meat. Put it into a bowl shaped plate add stock(1). Start cooking. Prepare all ingredients for the Mix for sauce(2). As soon as oven beeps, pour the mix into stock with stuffed pepper. Upside down it and continue cooking process.
<b>4-2 Fish Pie Rasstegai</b>	(1) Frozen puff pastry (2 square forms) - ¼ part of form (2) Filling: Pike perch filet small diced - 25 g, Champignons diced - 6 g, Cooked regular rice - 4 g, Egg yolk - ¼ pc for brushing
	Defrost the pastry. Cut pastry to necessary size(1). Mix all ingredients for filling(2). Put filling in the center of piece of pastry. Form it to boat. Brush it with egg yolk. Put it on a plate. Put the plate on the low rack. Start cooking. As soon as oven beeps, remove the boat from the plate to wax paper. Put boat with wax on the grill rack. Continue cooking process.
<b>4-3 Cheese in Bread Crumbs</b>	Cheese - 125 g (4 to 5 pc per 25 g each), Egg - 0.5 pc, Bread crumbs - 3 to 5 g
	Cut cheese into 5 x 5 cm square forms. Put into egg yolk and covered with bread crumbs. Preheat the oven 5 min Grill. Put cheese on a wax paper. Then put it on the grill rack. Start cooking.
<b>4-4 Chicken Shashlik</b>	Chicken leg filet - 380 g, Tomato paste - 20 g, Salt - 5 g, Garlic chopped - 3 g, Oil - 7 g, Regular yogurt - 70 g, Sticks. For marinate: tomatoes, olive oil, salt, pepper, lemon peel
	Cut filet into 3 x 3 cm dices. For marinate mix tomatoes smashed in blender, olive oil, salt, pepper, lemon peel. Mix marinate with chicken filet. Pickle meat for more than 1 hour. Put chicken pieces to the wooden skewers. Put it on the plate and on the high rack. Start cooking.



(continued)

Code/Food	Ingredients / Instructions
4-5 Boyar Style Meat	Pork neck - 280 g (cut in 4 pieces), Salt - 2 g, Black pepper powder - 0.5 g, Champignons slices - 45 g, Mayonnaise - 55 g
	Season meat. Put meat on the plate. Put plate on the high rack. Start cooking. As soon as oven beeps, put champignons on meat and cover with mayonnaise. Continue cooking process.
4-6 Coulbiac with Salmon	Frozen puff pastry - 130 g Filling: Salmon filet small diced - 100 g, Salt - 1 g, Pan fried onion diced - 20 g, Hardboiled egg small diced - 30 g, Egg yolk - 1 pc for brushing
	Defrost pastry. Roll it to 2 mm thin. Mix all ingredients for filling. Put filling in the center of pastry. Combine ends of the pastry together. Form it. Make some cuts. Brush it by egg yolk. Put formed pastry on a wax paper. Then put it on the low rack. Start cooking.
4-7 Salmon Shashlik	Salmon big diced - 350 to 370 g, Lemon - 25 g (squeeze juice), Salt - 5 g, Oil - 10 g, Parsley chopped - 10 g, Sticks
	Mix all ingredients and fish. Marinate 15 - 20 min. Put on sticks it. Put it on the plate and on the high rack. Start cooking.
4-8 Trout Baked with Vegetables	Butter - 5 g, Carrot julienned - 35 g, Onion julienned - 25 g, Garlic chopped - 3 g, Celery leaves chopped - 5 g, Trout - 1 pc (220 to 250 g), Salt - 1 g, White pepper powder - 0.5 g, Butter - 5 g
	Grease butter in the centre of wax paper. Put carrot, onion, garlic and celery on it. Put seasoned trout on vegetables. Grease butter on top of the fish. Cover it. Put it into microwave oven and start cooking.
4-9 Cookies	Wheat - 85 g, Ice sugar - 25 g, Butter - 50 g, Egg - 0.5 ps, Salt - 1 g
	Mix well wheat, ice sugar and butter. Add salt and egg. Mix well. Form it in two tablet forms. Put it with wax paper on the low rack. Start cooking.
4-10 Cranberry Fruit Drink	Frozen cranberry - 50 g, Sugar - 35 g, Water - 200 ml
	Frozen cranberry cut by mincer. Put all ingredients into a big bowl. Start cooking. Cool and strain.

## USING THE HEALTHY COOKING FEATURES

The Healthy Cooking features has twenty pre-programmed cooking times. You do not need to set either the cooking times or the power level. You can adjust the serving size of the item by turning the dial knob.

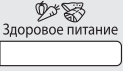
First, place the food in the centre of the turntable and close the door.

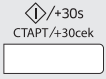
	<b>1.</b> Press the <b>Healthy Cooking</b> button.
	<b>2.</b> Select the category that you are cooking by turning the <b>Dial Knob</b> . At that time, press the <b>Dial Knob</b> . And then, select the food that you are cooking by turning the <b>Dial Knob</b> . At that time, press the <b>Dial Knob</b> . Refer to the table on the following page for a description of the various pre-programmed settings.
	<b>3.</b> Set the weight of food by turning the <b>Dial Knob</b> . (Broccoli, Peeled Potatoes only)
	<b>4.</b> Press the <b>START/+30s</b> button. <b>Result:</b> Cooking starts. When it has finished. 1) The oven beeps 4 times. 2) The end reminder signal will beep 3 times (once every minute). 3) The current time is displayed again.

 Use only recipients that are microwave-safe.

## 1. Vegetables &amp; Grain

Code/Food	Serving Size	Instructions
<b>1-1 Broccoli</b>	250 g 500 g	Rinse and clean fresh broccoli and prepare florets. Put them evenly into a glass bowl with lid. Add 30 ml (2 tbsp) water when cooking for 250 g, and add 60-75 ml (4-5 tbsp) for 500 g. Put bowl in the centre of turntable. Cook covered. Stir after cooking. Stand for 1-2 minutes.
<b>1-2 Carrots</b>	250 g	Rinse and clean carrots and prepare even slices. Put them evenly into a glass bowl with lid. Add 30 ml (2 tbsp) water when cooking for 250 g. Put bowl in the centre of turntable. Cook covered. Stir after cooking. Stand for 1-2 minutes.
<b>1-3 Green Beans</b>	250 g	Rinse and clean green beans. Put them evenly into a glass bowl with lid. Add 30 ml (2 tbsp) water when cooking 250 g. Put bowl in the centre of turntable. Cook covered. Stir after cooking. Stand for 1-2 minutes.
<b>1-4 Spinach</b>	150 g	Rinse and clean spinach. Put into a glass bowl with lid. Do not add water. Put bowl in the centre of turntable. Cook covered. Stir after cooking. Stand for 1-2 minutes.
<b>1-5 Corn on the Cob</b>	250 g (1 pcs)	Rinse and clean corn on the cob and put into an oval glass dish. Cover with microwave cling film and pierce film. Stand for 1-2 minutes.
<b>1-6 Peeled Potatoes</b>	250 g 500 g	Wash and peel the potatoes and cut into a similar size. Put them into a glass bowl with lid. Add 45-60 ml (3-4 tbsp) water. Put bowl in the centre of turntable. Cook covered. Stand for 2-3 minutes.

Code/Food	Serving Size	Instructions
<b>1-7 Brown Rice (Parboiled)</b>	125 g	Use a large glass ovenware dish with lid. Add double quantity of cold water (250 ml). Cook covered. Stir before standing time and add salt and herbs. Stand for 5-10 minutes.
<b>1-8 Wholemeal Macaroni</b>	125 g	Use a large glass ovenware dish with lid. Add 500 ml hot boiling water, a pinch of salt and stir well. Cook uncovered. Stir before standing time and drain thoroughly afterwards. Stand for 1 minutes.
<b>1-9 Quinoa</b>	125 g	Use a large glass ovenware dish with lid. Add double quantity of cold water (250 ml). Cook covered. Stir before standing time and add salt and herbs. Stand for 1-3 minutes.
<b>1-10 Bulgur</b>	125 g	Use a large glass ovenware dish with lid. Add double quantity of cold water (250 ml). Cook covered. Stir before standing time and add salt and herbs. Stand for 2-5 minutes.
<b>1-11 Vegetable Gratin</b>	500 g	Put the vegetables, such as precooked potato slices, courgette slices and tomatoes and sauce into a suitable sized glass pyrex dish. Add grated cheese on top. Put dish on the rack. Stand for 2-3 minutes.
<b>1-12 Grilled Tomatoes</b>	400 g	Rinse and clean tomatoes, cut them into halves and put in an ovenware dish. Add grated cheese on top. Put dish on rack. Stand for 1-2 minutes.

## 2. Poultry & Fish

Code/Food	Serving Size	Instructions
2-1 Chicken Breasts	300 g (2 pcs)	Rinse pieces and put on a ceramic plate. Cover with microwave cling film. Pierce film. Put dish on turntable. Stand for 2 minutes.
2-2 Turkey Breasts	300 g (2 pcs)	Rinse pieces and put on a ceramic plate. Cover with microwave cling film. Pierce film. Put dish on turntable. Stand for 2 minutes.
2-3 Fresh Fish Fillets	300 g (2 pcs)	Rinse fish and put on a ceramic plate, add 1 tbsp lemon juice. Cover with microwave cling film. Pierce film. Put dish on turntable. Stand for 1-2 minutes.
2-4 Fresh Salmon Fillets	300 g (2 pcs)	Rinse fish and put on a ceramic plate, add 1 tbsp lemon juice. Cover with microwave cling film. Pierce film. Put dish on turntable. Stand for 1-2 minutes.
2-5 Fresh Prawns	250 g	Rinse prawns on a ceramic plate, add 1 tbsp lemon juice. Cover with microwave cling film. Pierce film. Put dish on turntable. Stand for 1-2 minutes.
2-6 Fresh Trout	200 g (1 fish)	Put 1 fresh whole fish into an ovenproof dish. Add a pinch salt, 1 tbsp lemon juice and herbs. Cover with microwave cling film. Pierce film. Put dish on turntable. Stand for 2 minutes.
2-7 Roast Fish	200 g (1 fish)	Brush skin of whole fish (trout or gillthead) with oil and add herbs and spices. Put fish side by side, head to tail on the high rack. Turnover, as soon as the beep sounds. Stand for 3 minutes.
2-8 Grilled Salmon Steaks	300 g (2 steaks)	Put fish steaks evenly on the high rack. Turnover, as soon as the beep sounds. Stand for 2 minutes.

## POWER STEAM COOKING GUIDE (ONLY MG23H3115P\*, MG23H3115X\* MODELS)

The Power Steamer is based on the principle of steam cooking, and is designed for fast, healthy cooking in your Samsung Microwave oven.

This accessory is ideal for cooking rice, pasta, vegetables, etc. in record time, while preserving their nutritional values.

The Microwave Power Steamer set is made up of 3 items:



Bowl



Insert tray

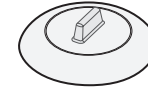

Lid

All parts withstand temperatures from -20 °C to 140 °C.

Suitable for freezer storage. Can also be used separately or together.

### CONDITIONS of USE:

- Do not use:
  - to cook foods with a high sugar or fat content,
  - with the grill or rotating heat function or on a hob.
- Wash all parts well in soapy water before first use.
- To find out cooking times, please refer to the instructions in the table on next page.

### MAINTENANCE:

- Your steamer can be washed in a dishwasher.
- When washing by hand, use hot water and washing-up liquid. Do not use abrasive pads.
- Some foods (such as tomato) may discolour the plastic. This is normal and not a manufacturing fault.

**COOKING:**

Food	Serving Size	Power levels	Cooking time (min.)	Handling
Artichokes	300 g (1-2 pcs)	800 W	5-6	Bowl with insert tray + Lid
	<b>Instructions</b> Rinse and clean artichokes. Put insert tray into bowl. Set artichokes on tray. Add 1 tbsp lemon juice. Cover with lid. Stand for 1-2 minutes.			
Fresh Vegetables	300 g	800 W	4-5	Bowl with insert tray + Lid
	<b>Instructions</b> Weigh the vegetables (e.g. broccoli, cauliflower, carrots, pepper) after washing, cleaning and cutting into similar size. Put tray into bowl. Distribute vegetables on insert tray. Add 2 tbsp water. Cover with lid. Stand for 1-2 minutes.			
Frozen Vegetables	300 g	600 W	7-8	Bowl with insert tray + Lid
	<b>Instructions</b> Put the frozen vegetables into the steam bowl. Put insert tray into bowl. Add 1 tbsp water. Cover with lid. Stir well after cooking and standing. Stand for 2-3 minutes.			
Rice	250 g	800 W	15-18	Bowl + Lid
	<b>Instructions</b> Put rice into the steam bowl. Add 500 ml cold water. Cover with lid. After cooking let stand white rice 5 minutes, brown rice 10 minutes.			
Jacket Potatoes	500 g	800 W	7-8	Bowl + Lid
	<b>Instructions</b> Weigh and rinse the potatoes and put them into steam bowl. Add 3 tbsp water. Cover with lid. Stand for 2-3 minutes.			
Stew (Chilled)	400 g	600 W	5-6	Bowl + Lid
	<b>Instructions</b> Put stew into the steam bowl. Cover with lid. Stir well before standing. Stand for 1-2 minutes.			



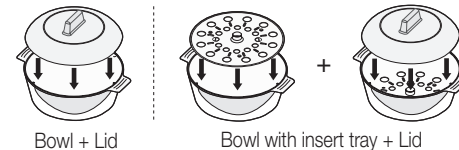

Food	Serving Size	Power levels	Cooking time (min.)	Handling
Soup (Chilled)	400 g	800 W	3-4	Bowl + Lid
	<b>Instructions</b> Pour into steam bowl. Cover with lid. Stir well before standing. Stand for 1-2 minutes.			
Frozen Soup	400 g	800 W	8-10	Bowl + Lid
	<b>Instructions</b> Put frozen soup into steam bowl. Cover with lid. Stir well before standing. Stand for 2-3 minutes.			
Frozen Yeast Dumpling with Jam Filling	150 g	600 W	1-2	Bowl + Lid
	<b>Instructions</b> Moist the top of filled dumplings with cold water. Put 1-2 frozen dumplings side by side into the steam bowl. Cover with lid. Stand for 2-3 minutes.			
Fruit Compote	250 g	800 W	3-4	Bowl + Lid
	<b>Instructions</b> Weigh the fresh fruits (e.g. apples, pears, plums, apricots, mangoes or pineapple) after peeling, washing and cutting into similar sizes or cubes. Put into steam bowl. Add 1-2 tbsp water and 1-2 tbsp sugar. Cover with lid. Stand for 2-3 minutes.			





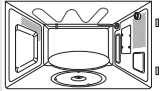
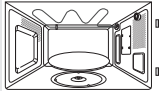

**Handling of power steam cooker****PRECAUTIONS:**

- Take special care when opening the lid of your steamer, because the steam escaping may be very hot.
- Use oven gloves when handling after cooking.

## USING THE CRUSTY PLATE (ONLY MG23H3115N\*, MG23H3115X\* MODELS)

This crusty plate allows you to brown food not only on the top with the grill, but also the bottom of the food turns crispy and brown due to the high temperature of the crusty plate. Several items which you can prepare on the crusty plate can be found in the chart (see next page). The crusty plate can also be used for bacon, eggs, sausages, etc.

	<b>1.</b> Place the crusty plate directly on the turntable and preheat it with highest Microwave-Grill-Combination [600 W + Grill] by following the times and instructions in the chart.
	<b>2.</b> Brush the plate with oil if you are cooking food, such as bacon and eggs, in order to brown the food nicely.
	<b>3.</b> Place the food on the crusty plate.
	<b>4.</b> Place the crusty plate on the metal rack (or turntable) in the microwave.
	<b>5.</b> Select the appropriate cooking time and power. (Refer to the table on the side)

-  Always use oven gloves to take out the crusty plate, as will become very hot.
-  Please note that the crusty plate has a teflon layer which is not scratch-resistant. Do not use any sharp objects like a knife to cut on the crusty plate.
-  Do not place any objects on the crusty plate that are not heat-resistant.
-  Never place the crusty plate in the oven without turntable.
-  Clean the crusty plate with warm water and detergent and rinse off with clean water.
-  Do not use a scrubbing brush or a hard sponge otherwise the top layer will be damaged.
-  Please note that the crust plate is not dish washer-safe.

We recommend to preheat the crusty plate directly on the turntable. Preheat crusty plate with 600 W + Grill function for 3-4 minutes. Follow the times and instructions in the table.





Food	Serving Size	Power	Cooking time (min.)
Bacon	4 slices (80 g)	600 W + Grill	3½-4
	<b>Instructions</b> Preheat crusty plate. Put slices side by side on crusty plate. Put crusty plate on the rack. Stand for 3 minutes.		
Grilled Tomatoes	200 g (2 pcs)	450 W + Grill	4½-5
	<b>Instructions</b> Preheat crusty plate. Cut tomatoes in halves. Put some cheese on top. Arrange in a circle on crusty plate. Put crusty plate on the rack. Stand for 3 minutes.		
Burger (Frozen)	2 pieces (125 g)	600 W + Grill	7-7½
	<b>Instructions</b> Preheat crusty plate. Put frozen burger in a circle on crusty plate. Put crusty plate on the rack. Turn over after 4-5 min. Stand for 3 minutes.		
Baguettes (Frozen)	200-250 g (2 pcs)	450 W + Grill	8-9
	<b>Instructions</b> Preheat crusty plate. Put 1 baguette beside the centre, 2 baguettes side by side on the plate. Put crusty plate on rack. Stand for 4 minutes.		
Pizza (Frozen)	300-350 g	450 W + Grill	7½-8½
	<b>Instructions</b> Preheat crusty plate. Put the frozen pizza on the crusty plate. Put crusty plate on the Turntable. Stand for 2 minutes.		
Baked Potatoes	250 g 500 g	600 W + Grill	5-6 8-9
	<b>Instructions</b> Preheat crusty plate. Cut potatoes in halves. Put them on the crusty plate with the cut side to the bottom. Arrange in a circle. Put the plate on the rack. Stand for 3 minutes.		

Food	Serving Size	Power	Cooking time (min.)
Fish Fingers (Frozen)	150 g (5 pcs) 300 g (10 pcs)	600 W + Grill	7-8 9-10
	<b>Instructions</b> Preheat crusty plate. Brush plate with 1 tbsp oil. Put fish fingers in a circle on the plate. Turn over after 4 min. (5 pc) or after 6 min. (10 pc). Stand for 4 minutes.		
Chicken Nuggets (Frozen)	125 g 250 g	600 W + Grill	5-5½ 7½-8
	<b>Instructions</b> Preheat crusty plate. Brush plate with 1 tbsp. Put chicken nuggets on the plate. Put crusty plate on the rack. Turn over after 3 min. (125 g) or 5 min. (250 g). Stand for 4 minutes.		
Pizza (Chilled)	300-350 g	450 W + Grill	6½-7½

## USING THE AUTO POWER DEFROST FEATURES

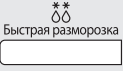
The Auto Power Defrost features enables you to defrost meat, poultry, fish, fruit/berry. The defrost time and power level are set automatically. You simply select the programme and the weight.

First, place the frozen food in the centre of the turntable and close the door.

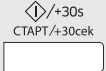
	1. Press the <b>Power Defrost</b> button.
	2. Select the type of food that you are cooking by turning the <b>Dial Knob</b> . (Refer to the table on the side).
	3. Press the <b>Dial Knob</b> to select the type of food.
	4. Set the weight of food by turning the <b>Dial Knob</b> .
	5. Press the <b>START/+30s</b> button. <b>Result:</b> <ul style="list-style-type: none"> <li>• Defrosting begins.</li> <li>• The oven beeps half way through defrosting to remind you to turn the food over.</li> <li>• Press <b>START/+30s</b> button again to finish defrosting.</li> </ul>

 You can also defrost food manually. To do so, select the microwave cooking/reheating function with a power level of 180 W. Refer to the section entitled "Cooking/Reheating" on page 15 for further details.

 Use only dishes that are microwave-safe.

The following table presents the various Auto Power Defrost programmes, quantities and appropriate instructions. Remove all kinds of package material before defrosting. Place meat, poultry, fish, fruit/berry on a ceramic plate.



Code/Food	Serving Size	Instructions
<b>1 Meat</b>	200-1500 g	Shield the edges with aluminium foil. Turn the meat over when the oven beeps. This programme is suitable for beef, lamb, pork, steaks, chops and minced meat. Stand for 10-30 minutes.
<b>2 Poultry</b>	200-1500 g	Shield the leg and wing tips with aluminium foil. Turn the poultry over when the oven beeps. This programme is suitable for whole chicken and chicken portions. Stand for 10-30 minutes.
<b>3 Fish</b>	200-1500 g	Shield the tail of the whole fish with aluminium foil. Turn the fish over when the oven beeps. This programme is suitable for whole fishes and fish fillets. Stand for 10-30 minutes.
<b>4 Fruit/Berry</b>	100-600 g	Spread fruits evenly into a flat glass dish. This programme is suitable for all kind of fruits.

 Select the Manual Defrosting function with a power level of 180 W if you want to defrost food manually. For further details on manual defrosting and defrosting time, refer to the page 36.

## USING THE MY PLATE FEATURES

The My Plate features has 2 pre-programmed cooking times. You do not need to set either the cooking times or the power level. You can adjust the number of servings by turning the dial knob.

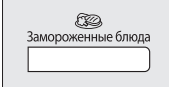
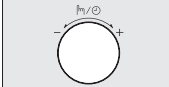
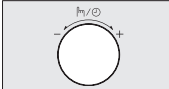
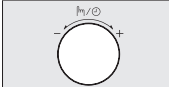
First, place the food in the centre of the turntable and close the door.

	<b>1.</b> Press the <b>My plate</b> button.
	<b>2.</b> Select the type of food that you are cooking by turning the <b>Dial Knob</b> .
	<b>3.</b> Press the <b>Dial Knob</b> to select the type of food.
	<b>4.</b> Select the size of the serving by turning the <b>Dial Knob</b> . (Refer to the table on the side.)
	<b>5.</b> Press the <b>START/+30s</b> button. <b>Result:</b> Cooking starts. When it has finished. 1) The oven beeps 4 times. 2) The end reminder signal will beep 3 times (once every minute). 3) The current time is displayed again.

 Use only recipients that are microwave-safe.



The following table presents the My Plate programmes, quantities and appropriate instructions. Those programmes are running with microwave energy only.

Code/Food	Serving Size	Instructions
<b>1</b> Chilled Ready Meal	300-350 g 400-450 g	Put on a ceramic plate and cover with microwave cling film. This programme is suitable for meals consisting of 3 components (e.g. meat with sauce, vegetables and a side dishes like potatoes, rice or pasta). Stand for 2-3 minutes.
<b>2</b> Chilled Vegetarian Meal	300-350 g 400-450 g	Put meal on a ceramic plate and cover with microwave cling film. This programme is suitable for meals consisting of 2 components (e.g. spaghetti with sauce or rice with vegetables). Stand for 2-3 minutes.

## CHOOSING THE ACCESSORIES



Use microwave-safe recipients; do not use plastic containers, dishes, paper cups, towels, etc.  
If you wish to select the combined cooking mode (grill and microwave), use only dishes that are microwave-safe and ovenproof.

- For further details on suitable cookware and utensils, refer to the Cookware Guide on page 31.

## GRILLING



The grill enables you to heat and brown food quickly, without using microwaves. For this purpose, a grill rack is supplied with your microwave oven.





	<b>1.</b> Preheat the grill to the required temperature, by pressing the <b>Grill</b> button and set the preheat time by turning the <b>Dial Knob</b> .
	<b>2.</b> Press the <b>START/+30s</b> button.
	<b>3.</b> After preheating, open the door and place the food on the rack. Close the door.
	<b>4.</b> Press the <b>Grill</b> button. <b>Result:</b> The following indications are displayed: 
	<b>5.</b> Set the Grilling time by turning the <b>Dial Knob</b> . The maximum grilling time is 60 minutes.
	<b>6.</b> Press the <b>START/+30s</b> button. <b>Result:</b> Grilling cooking start. When it has finished. 1) The oven beeps 4 times. 2) The end reminder signal will beep 3 times (once every minute). 3) The current time is displayed again.

- Do not worry if the heater turns off and on while grilling. This system is designed to prevent overheating of the oven.
- Always use oven gloves when touching the dishes in the oven, as they will be very hot.

## COMBINING MICROWAVES AND THE GRILL

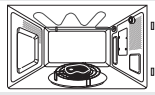
You can also combine microwave cooking with the grill, to cook quickly and brown at the same time.

-  **ALWAYS** use microwave-safe and oven-proof cookware. Glass or ceramic dishes are ideal as they allow the microwaves to penetrate the food evenly.
-  **ALWAYS** use oven gloves when touching the recipients in the oven, as they will be very hot.





	<ol style="list-style-type: none"> <li>Open the oven door. Place the food on the rack and the rack on the turntable. Close the door.</li> </ol>
 Комби	<ol style="list-style-type: none"> <li>Press the <b>Combi</b> button.</li> </ol>
	<ol style="list-style-type: none"> <li>Turn <b>Dial Knob</b> to desired until the appropriate power level is displayed. At that time, press the <b>Dial Knob</b> to set the power level.</li> </ol>
	<ol style="list-style-type: none"> <li>Set the Cooking time by turning the <b>Dial Knob</b>. The maximum grilling time is 60 minutes.</li> </ol>
	<ol style="list-style-type: none"> <li>Press the <b>START/+30s</b> button. <b>Result:</b> Combination cooking starts. When it has finished.               <ol style="list-style-type: none"> <li>The oven beeps 4 times.</li> <li>The end reminder signal will beep 3 times (once every minute).</li> <li>The current time is displayed again.</li> </ol> </li> </ol>

 The maximum microwave power for the combined microwave and grill mode is 600 W.

 You cannot set the temperature of the grill.

## SWITCHING THE BEEPER OFF



You can switch the beeper off whenever you want.

	<ol style="list-style-type: none"> <li>Press the <b>STOP/ECO</b> and <b>START/+30s</b> buttons at the same time. <b>Result:</b> <ul style="list-style-type: none"> <li>The following indication is displayed. </li> <li>The oven does not beep each time you press a button.</li> </ul> </li> </ol>
	<ol style="list-style-type: none"> <li>To switch the beeper back on, press the <b>STOP/ECO</b> and <b>START/+30s</b> buttons again at the same time. <b>Result:</b> <ul style="list-style-type: none"> <li>The following indication is displayed. </li> <li>The oven operates with the beeper on again.</li> </ul> </li> </ol>

## SAFETY-LOCKING YOUR MICROWAVE OVEN

Your microwave oven is fitted with a special Child Safety programme, which enables the oven to be "locked" so that children or anyone unfamiliar with it cannot operate it accidentally.

The oven can be locked at any time.

	<ol style="list-style-type: none"> <li>Press the <b>Child Lock</b> button for three seconds. <b>Result:</b> <ul style="list-style-type: none"> <li>The oven is locked (no functions can be selected).</li> <li>The display shows "L". </li> </ul> </li> </ol>
	<ol style="list-style-type: none"> <li>To unlock the oven, press the <b>Child Lock</b> button for three seconds. <b>Result:</b> The oven can be used normally.</li> </ol>

## cookware guide

To cook food in the microwave oven, the microwaves must be able to penetrate the food, without being reflected or absorbed by the dish used.

Care must therefore be taken when choosing the cookware. If the cookware is marked microwave-safe, you do not need to worry.

The following table lists various types of cookware and indicates whether and how they should be used in a microwave oven.

Cookware	Microwave-safe	Comments
<b>Aluminum foil</b>	✓ x	Can be used in small quantities to protect areas against overcooking. Arcing can occur if the foil is too close to the oven wall or if too much foil is used.
<b>Crust plate</b>	✓	Do not preheat for more than 8 minutes.
<b>China and earthenware</b>	✓	Porcelain, pottery, glazed earthenware and bone china are usually suitable, unless decorated with a metal trim.
<b>Disposable polyester cardboard dishes</b>	✓	Some frozen foods are packaged in these dishes.
<b>Fast-food packaging</b>		
• Polystyrene cups containers	✓	Can be used to warm food. Overheating may cause the polystyrene to melt.
• Paper bags or newspaper	x	May catch fire.
• Recycled paper or metal trims	x	May cause arcing.

Cookware	Microwave-safe	Comments
<b>Glassware</b>		
• Oven-to-tableware	✓	Can be used, unless decorated with a metal trim.
• Fine glassware	✓	Can be used to warm foods or liquids. Delicate glass may break or crack if heated suddenly.
• Glass jars	✓	Must remove the lid. Suitable for warming only.
<b>Metal</b>		
• Dishes	x	May cause arcing or fire.
• Freezer bag twist ties	x	
<b>Paper</b>		
• Plates, cups, napkins and kitchen paper	✓	For short cooking times and warming. Also to absorb excess moisture.
• Recycled paper	x	May cause arcing.
<b>Plastic</b>		
• Containers	✓	Particularly if heat-resistant thermoplastic. Some other plastics may warp or discolour at high temperatures. Do not use Melamine plastic.
• Cling film	✓	Can be used to retain moisture. Should not touch the food. Take care when removing the film as hot steam will escape.
• Freezer bags	✓ x	Only if boilable or oven-proof. Should not be airtight. Prick with a fork, if necessary.
<b>Wax or grease-proof paper</b>	✓	Can be used to retain moisture and prevent spattering.

✓ : Recommended

✓ x : Use Caution

x : Unsafe

English - 31

# cooking guide

## MICROWAVES

Microwave energy actually penetrates food, attracted and absorbed by its water, fat and sugar content.

The microwaves cause the molecules in the food to move rapidly. The rapid movement of these molecules creates friction and the resulting heat cooks the food.

## COOKING

### Cookware for microwave cooking:

Cookware must allow microwave energy to pass through it for maximum efficiency. Microwaves are reflected by metal, such as stainless steel, aluminium and copper, but they can penetrate through ceramic, glass, porcelain and plastic as well as paper and wood. So food must never be cooked in metal containers.

### Food suitable for microwave cooking:

Many kinds of food are suitable for microwave cooking, including fresh or frozen vegetables, fruit, pasta, rice, grains, beans, fish, and meat. Sauces, custard, soups, steamed puddings, preserves, and chutneys can also be cooked in a microwave oven. Generally speaking, microwave cooking is ideal for any food that would normally be prepared on a hob. Melting butter or chocolate, for example (see the chapter with tips, techniques and hints).

### Covering during cooking

To cover the food during cooking is very important, as the evaporated water rises as steam and contributes to cooking process. Food can be covered in different ways: e.g. with a ceramic plate, plastic cover or microwave suitable cling film.

### Standing times

After cooking is over food the standing time is important to allow the temperature to even out within the food.

## Cooking guide for frozen vegetables

Use a suitable glass pyrex bowl with lid. Cook covered for the minimum time - see table. Continue cooking to get the result you prefer.

Stir twice during cooking and once after cooking. Add salt, herbs or butter after cooking. Cover during standing time.

Food	Serving Size	Power	Time (min.)
Spinach	150 g	600 W	4½-5½
	<b>Instructions</b> Add 15 ml (1 tbsp) cold water. Stand for 2-3 minutes.		
Broccoli	300 g	600 W	9-10
	<b>Instructions</b> Add 30 ml (2 tbsp) cold water. Stand for 2-3 minutes.		
Peas	300 g	600 W	7½-8½
	<b>Instructions</b> Add 15 ml (1 tbsp) cold water. Stand for 2-3 minutes.		
Green Beans	300 g	600 W	8-9
	<b>Instructions</b> Add 30 ml (2 tbsp) cold water. Stand for 2-3 minutes.		
Mixed Vegetables (Carrots/Peas/Corn)	300 g	600 W	7½-8½
	<b>Instructions</b> Add 15 ml (1 tbsp) cold water. Stand for 2-3 minutes.		
Mixed Vegetables (Chinese Style)	300 g	600 W	8-9
	<b>Instructions</b> Add 15 ml (1 tbsp) cold water. Stand for 2-3 minutes.		

### Cooking Guide for rice and pasta

- Rice :** Use a large glass pyrex bowl with lid - rice doubles in volume during cooking. Cook covered.  
After the cooking time is over, stir before standing time and salt or add herbs and butter.  
Remark: the rice may not have absorbed all water after the cooking time is finished.
- Pasta :** Use a large glass pyrex bowl. Add boiling water, a pinch of salt and stir well. Cook uncovered.  
Stir occasionally during and after cooking. Cover during standing time and drain thoroughly afterwards.

Food	Serving Size	Power	Time (min.)
White Rice (Parboiled)	250 g	800 W	16-17
	<b>Instructions</b> Add 500 ml cold water. Stand for 5 minutes.		
Brown Rice (Parboiled)	250 g	800 W	21-22
	<b>Instructions</b> Add 500 ml cold water. Stand for 5 minutes.		
Mixed Rice (Rice + Wild Rice)	250 g	800 W	17-18
	<b>Instructions</b> Add 500 ml cold water. Stand for 5 minutes.		
Mixed Corn (Rice + Grain)	250 g	800 W	18-19
	<b>Instructions</b> Add 400 ml cold water. Stand for 5 minutes.		
Pasta	250 g	800 W	11-12
	<b>Instructions</b> Add 1000 ml hot water. Stand for 5 minutes.		

### Cooking Guide for fresh vegetables

Use a suitable glass pyrex bowl with lid. Add 30-45 ml cold water (2-3 tbsp) for every 250 g unless another water quantity is recommended – see table. Cook covered for the minimum time – see table. Continue cooking to get the result you prefer. Stir once during and once after cooking. Add salt, herbs or butter after cooking.  
Cover during a standing time of 3 minutes.

- Hint :** Cut the fresh vegetables into even sized pieces. The smaller they are cut, the quicker they will cook.

Food	Serving Size	Power	Time (min.)
Broccoli	250 g	800 W	4-4½
	500 g		7-7½
<b>Instructions</b> Prepare even sized florets. Arrange the stems to the centre. Stand for 3 minutes.			
Brussels Sprouts	250 g	800 W	5½-6½
	<b>Instructions</b> Add 60-75 ml (4-5 tbsp) water. Stand for 3 minutes.		
Carrots	250 g	800 W	4½-5
	<b>Instructions</b> Cut carrots into even sized slices. Stand for 3 minutes.		
Cauliflower	250 g	800 W	5-5½
	500 g		8½-9
<b>Instructions</b> Prepare even sized florets. Cut big florets into halves. Arrange stems to the centre. Stand for 3 minutes.			
Courgettes	250 g	800 W	3½-4
	<b>Instructions</b> Cut courgettes into slices. Add 30 ml (2 tbsp) water or a knob of butter. Cook until just tender. Stand for 3 minutes.		
Egg Plants	250 g	800 W	3½-4
	<b>Instructions</b> Cut egg plants into small slices and sprinkle with 1 tbsp lemon juice. Stand for 3 minutes.		

(continued)

Food	Serving Size	Power	Time (min.)
Leeks	250 g	800 W	4½-5
	<b>Instructions</b> Cut leeks into thick slices. Stand for 3 minutes.		
Mushrooms	125 g	800 W	1½-2
	250 g		3-3½
<b>Instructions</b> Prepare small whole or sliced mushrooms. Do not add any water. Sprinkle with lemon juice. Spice with salt and pepper. Drain before serving. Stand for 3 minutes.			
Onions	250 g	800 W	5½-6
	<b>Instructions</b> Cut onions into slices or halves. Add only 15 ml (1 tbsp) water. Stand for 3 minutes.		
Pepper	250 g	800 W	4½-5
	<b>Instructions</b> Cut pepper into small slices. Stand for 3 minutes.		
Potatoes	250 g	800 W	4-5
	500 g		7½-8½
<b>Instructions</b> Weigh the peeled potatoes and cut them into similar sized halves or quarters. Stand for 3 minutes.			
Turnip Cabbage	250 g	800 W	5-5½
	<b>Instructions</b> Cut turnip cabbage into small cubes. Stand for 3 minutes.		

## REHEATING

Your microwave oven will reheat food in a fraction of the time that conventional ovens hobs normally take.

Use the power levels and reheating times in the following chart as a guide. The times in the chart consider liquids with a room temperature of about +18 to +20 °C or a chilled food with a temperature of about +5 to +7 °C.

### Arranging and covering

Avoid reheating large items such as joint of meat – they tend to overcook and dry out before the centre is piping hot. Reheating small pieces will be more successful.

### Power levels and stirring

Some foods can be reheated using 800 W power while others should be reheated using 600 W, 450 W or even 300 W.

Check the tables for guidance. In general, it is better to reheat food using a lower power level, if the food is delicate, in large quantities, or if it is likely to heat up very quickly (mince pies, for example).

Stir well or turn food over during reheating for best results. When possible, stir again before serving.

Take particular care when heating liquids and baby foods. To prevent eruptive boiling of liquids and possible scalding, stir before, during and after heating. Keep them in the microwave oven during standing time. We recommend putting a plastic spoon or glass stick into the liquids. Avoid overheating (and therefore spoiling) the food.

It is preferable to underestimate cooking time and add extra heating time, if necessary.

### Heating and standing times

When reheating food for the first time, it is helpful to make a note of the time taken – for future reference.

Always make sure that the reheated food is piping hot throughout.

Allow food to stand for a short time after reheating - to let the temperature even out.

The recommended standing time after reheating is 2-4 minutes, unless another time is recommended in the chart.

Take particular care when heating liquids and baby food. See also the chapter with the safety precautions.

## REHEATING LIQUIDS

Always allow a standing time of at least 20 seconds after the oven has been switched off to allow the temperature to even out. Stir during heating, if necessary, and ALWAYS stir after heating. To prevent eruptive boiling and possible scalding, you should put a spoon or glass stick into the beverages and stir before, during and after heating.

## Reheating Liquids and Food

Use the power levels and times in this table as a guide lines for reheating.

Food	Serving Size	Power	Time (min.)
Drinks (Coffee, Tea and Water)	150 ml (1 cup)	800 W	1-1½
	250 ml (1 mug)		1½-2
	<b>Instructions</b> Pour into cup and reheat uncovered. Put cup/ mug in the centre of turntable. Keep in microwave oven during standing time and stir well. Stand for 1-2 minutes.		
Soup (Chilled)	250 g	800 W	3-3½
	<b>Instructions</b> Pour into a deep ceramic plate. Cover with plastic lid. Stir well after reheating. Stir again before serving. Stand for 2-3 minutes.		
Stew (Chilled)	350 g	600 W	5½-6½
	<b>Instructions</b> Put stew in a deep ceramic plate. Cover with plastic lid. Stir occasionally during reheating and again before standing and serving. Stand for 2-3 minutes.		
Pasta with Sauce (Chilled)	350 g	600 W	4½-5½
	<b>Instructions</b> Put pasta (e.g. spaghetti or egg noodles) on a flat ceramic plate. Cover with microwave cling film. Stir before serving. Stand for 3 minutes.		
Filled Pasta with Sauce (Chilled)	350 g	600 W	5-6
	<b>Instructions</b> Put filled pasta (e.g. ravioli, tortellini) in a deep ceramic plate. Cover with plastic lid. Stir occasionally during reheating and again before standing and serving. Stand for 3 minutes.		
Plated Meal (Chilled)	350 g	600 W	5½-6½
	<b>Instructions</b> Plate a meal of 2-3 chilled components on a ceramic dish. Cover with microwave cling-film. Stand for 3 minutes.		

## REHEATING BABY FOOD

**BABY FOOD:** Empty into a deep ceramic plate. Cover with plastic lid. Stir well after reheating!

Let stand for 2-3 minutes before serving. Stir again and check the temperature.

Recommended serving temperature: between 30-40 °C.

**BABY MILK:** Pour milk into a sterilised glass bottle. Reheat uncovered. Never heat a baby's bottle with teat on, as the bottle may explode if overheated. Shake well before standing time and again before serving ! Always carefully check the temperature of baby milk or food before giving it to the baby. Recommended serving temperature: ca. 37 °C.

### REMARK:

Baby food particularly needs to be checked carefully before serving to prevent burns.

Use the power levels and times in the next table as a guide lines for reheating.

### Reheating baby food and milk

Use the power levels and times in this table as guide lines for reheating.

Food	Serving Size	Power	Time
Baby Food (Vegetables + Meat)	190 g	600 W	30 sec.
	<b>Instructions</b> Empty into ceramic deep plate. Cook covered. Stir after cooking time. Before serving, stir well and check the temperature carefully. Stand for 2-3 minutes.		
Baby Porridge (Grain + Milk + Fruit)	190 g	600 W	20 sec.
	<b>Instructions</b> Empty into ceramic deep plate. Cook covered. Stir after cooking time. Before serving, stir well and check the temperature carefully. Stand for 2-3 minutes.		
Baby Milk	100 ml	300 W	30-40 sec.
	200 ml		50 sec. to 1 min.
	<b>Instructions</b> Stir or shake well and pour into a sterilized glass bottle. Place into the centre of turn-table. Cook uncovered. Shake well and stand for at least 3 minutes. Before serving, shake well and check the temperature carefully. Stand for 2-3 minutes.		

## MANUAL DEFROSTING

Microwaves are an excellent way of defrosting frozen food. Microwaves gently defrost frozen food in a short period of time. This can be of great advantage, if unexpected guests suddenly show up.

Frozen poultry must be thoroughly thawed before cooking. Remove any metal ties and take it out of any wrapping to allow thawed liquid to drain away.

Put the frozen food on a dish without cover. Turn over half way, drain off any liquid and remove any giblets as soon as possible.

Check the food occasionally to make sure that it does not feel warm.

If smaller and thinner parts of the frozen food start to warm up, they can be shield by wrapping very small strips of aluminium foil around them during defrosting.

Should poultry start to warm up on the outer surface, stop thawing and allow it to stand for 20 minutes before continuing.

Leave the fish, meat and poultry to stand in order to complete defrosting. The standing time for complete defrosting will vary depending on the quantity defrosted. Please refer to the table below.

**Hint:** Flat food defrosts better than thick and smaller quantities need less time than bigger ones. Remember this hint while freezing and defrosting food.

For defrosting of frozen food with a temperature of about -18 to -20 °C, use the following table as a guide.

Food	Serving Size	Power	Time (min.)
<b>Meat</b>			
Minced Beef	250 g 500 g	180 W	6½-7½ 10-12
Pork Steaks	250 g	180 W	7½-8½
	<b>Instructions</b> Place the meat on a flat ceramic plate. Shield thinner edges with aluminium foil. Turn over after half of defrosting time! Stand for 5-25 minutes.		

Food	Serving Size	Power	Time (min.)
<b>Poultry</b>			
Chicken Pieces	500 g (2 pcs)	180 W	14½-15½
Whole Chicken	900 g	180 W	28-30
	<b>Instructions</b> First, put chicken pieces first skin-side down, whole chicken first breast-side-down on a flat ceramic plate. Shield the thinner parts like wings and ends with aluminium foil. Turn over after half of defrosting time! Stand for 15-40 minutes.		
<b>Fish</b>			
Fish Fillets	250 g (2 pcs) 400 g (4 pcs)	180 W	6-7 12-13
	<b>Instructions</b> Put frozen fish in the middle of a flat ceramic plate. Arrange the thinner parts under the thicker parts. Shield narrow ends with aluminium foil. Turn over after half of defrosting time! Stand for 5-15 minutes.		
<b>Fruits</b>			
Berries	250 g	180 W	6-7
	<b>Instructions</b> Distribute fruits on a flat, round glass dish (with a large diameter). Stand for 5-10 minutes.		
<b>Bread</b>			
Bread Rolls (Each about 50 g)	2 pcs 4 pcs	180 W	½-1 2-2½
Toast/Sandwich	250 g	180 W	4½-5
German Bread (Wheat + Rye Flour)	500 g	180 W	8-10
	<b>Instructions</b> Arrange rolls in a circle or bread horizontally on kitchen paper in the middle of turntable. Turn over after half of defrosting time! Stand for 5-20 minutes.		



## GRILL

The grill-heating element is located underneath the ceiling of the cavity. It operates while the door is closed and the turntable is rotating. The turntable's rotation makes the food brown more evenly. Preheating the grill for 3-4 minutes will make the food brown more quickly.

### Cookware for grilling:

Should be flameproof and may include metal. Do not use any type of plastic cookware, as it can melt.

### Food suitable for grilling:

Chops, sausages, steaks, hamburgers, bacon and gammon rashers, thin fish portions, sandwiches and all kinds of toast with toppings.

### Important remark:

Whenever the grill only mode is used, make sure that the grill-heating element is under the ceiling in the horizontal position and not on the back-wall in the vertical position. Please remember that food must be placed on the high rack, unless another instruction is recommended.

## MICROWAVE + GRILL

This cooking mode combines the radiant heat that is coming from the grill with the speed of microwave cooking. It operates only while the door is closed and the turntable is rotating. Due to the rotation of the turntable, the food browns evenly. Three combination modes are available with this model: 600 W + Grill, 450 W + Grill and 300 W + Grill.

### Cookware for cooking with microwave + grill

Please use cookware that microwaves can pass through. Cookware should be flameproof. Do not use metal cookware with combination mode. Do not use any type of plastic cookware, as it can melt.

### Food suitable for microwave + grill cooking:

Food suitable for combination mode cooking include all kinds of cooked food which need reheating and browning (e.g. baked pasta), as well as foods which require a short cooking time to brown the top of the food. Also, this mode can be used for thick food portions that benefit from a browned and crispy top (e.g. chicken pieces, turning them over half way through cooking). Please refer to the grill table for further details.

### Important remark:

Whenever the combination mode (microwave + grill) is used, make sure that the grill heating element is under the ceiling in the horizontal position and not on the back-wall in the vertical position. The food should be placed on the high rack, unless another instruction is recommended. Otherwise it has to be placed directly on the turntable. Please refer to the instructions in the following chart.

The food must be turned over, if it is to be browned on both sides.

## Grill Guide for frozen food

Use the power levels and times in this table as guide lines for grilling.

Frozen Food	Serving Size	Power	1 step (min.)	2 step (min.)
Bread Rolls (Each ca. 50 g)	2 pcs	MW + Grill	300 W + Grill	Grill only
	4 pcs		1-1½	1-2
<b>Instructions</b> Arrange rolls in a circle on rack. Grill the second side of the rolls up to the crisp you prefer. Stand for 2-5 minutes.				
Baguettes + Topping (Tomatoes, Cheese, Ham, Mushrooms)	250-300 g (2 pcs)	450 W + Grill	8-9	-
	<b>Instructions</b> Put 2 frozen baguettes side by side on the rack. After grilling, Stand for 2-3 minutes.			
Gratin (Vegetables or Potatoes)	400 g	450 W + Grill	13-14	-
	<b>Instructions</b> Put frozen gratin into a small, round glass pyrex dish. Put the dish on the rack. After grilling. Stand for 2-3 minutes.			
Pasta (Cannelloni, Macaroni, Lasagne)	400 g	MW + Grill	300 W + Grill	Grill only
	18-19			
<b>Instructions</b> Put frozen pasta into a small flat rectangular glass pyrex dish. Put the dish directly on the turntable. After grilling. Stand for 2-3 minutes.				
Chicken Nuggets	250 g	450 W + Grill	5-5½	3-3½
	<b>Instructions</b> Put chicken nuggets on the rack. Turn over after first time.			
Oven Chips	250 g	450 W + Grill	9-11	4-5
	<b>Instructions</b> Put oven chips evenly on baking paper on the rack.			

### Grill Guide for fresh food

Preheat the grill with the grill-function for 3-4 minutes.

Use the power levels and times in this table as guide lines for grilling.

Fresh Food	Serving Size	Power	1 step (min.)	2 step (min.)
Toast Slices	4 pcs (each 25 g)	Grill only	6-8	4-5½
	<b>Instructions</b> Put the toast slices side by side on the rack.			
Bread Rolls (Already Baked)	2-4 pieces	Grill only	2-3	2-3
	<b>Instructions</b> Put bread rolls first with the bottom side up in a circle directly on the turntable.			
Grilled Tomatoes	200 g (2 pcs)	MW + Grill	300 W + Grill	Grill only
	400 g (4 pcs)		4½-5½	2-3
	<b>Instructions</b> Cut tomatoes into halves. Put some cheese on top. Arrange in a circle in a flat glass pyrex dish. Place it on the rack.			
Toast Hawaii (Ham, Pineapple, Cheese Slices)	2 pcs (300 g)	450 W + Grill	3½-4	-
	<b>Instructions</b> Toast the bread slices first. Put the toast with topping on the rack. Put 2 toasts opposite directly on the rack. Stand for 2-3 minutes.			
Baked Potatoes	250 g	600 W + Grill	4½-5½	-
	500 g		8-9	
<b>Instructions</b> Cut potatoes into halves. Put them in a circle on the rack with the cut side to the grill.				

Fresh Food	Serving Size	Power	1 step (min.)	2 step (min.)
Chicken Pieces	450-500 g (2 pcs)	300 W + Grill	10-12	12-13
	<b>Instructions</b> Prepare chicken pieces with oil and spices. Put them in a circle with the bones to the middle. Put 1 chicken piece not into the centre of the rack. Stand for 2-3 minutes.			
Lamb Chops/ Beef Steaks (Medium)	400 g (4 pcs)	Grill only	12-15	9-12
	<b>Instructions</b> Brush the lamb chops with oil and spices. Lay them in a circle on the rack. After grilling. Stand for 2-3 minutes.			
Pork Steaks	250 g (2 pcs)	MW + Grill	300 W + Grill	Grill only
			7-8	6-7
<b>Instructions</b> Brush the pork steaks with oil and spices. Lay them in a circle on the rack. After grilling. Stand for 2-3 minutes.				
Baked Apples	1 apple (ca. 200 g)	300 W + Grill	4-4½	-
	2 apples (ca. 400 g)		6-7	
<b>Instructions</b> Core the apples and fill them with raisins and jam. Put some almond slices on top. Put apples on a flat glass pyrex dish. Place the dish directly on the turntable.				
Roast Chicken	1200 g	MW + Grill	450 W + Grill	300 W + Grill
			22-24	23-25
<b>Instructions</b> Brush chicken with oil and spices. Put chicken first breast side down, second breast side up on pyrex dish. Stand for 5 minutes after grilling.				

## TIPS AND TRICKS

### MELTING BUTTER

Put 50 g butter into a small deep glass dish. Cover with plastic lid. Heat for 30-40 seconds using 800 W, until butter is melted.

### MELTING CHOCOLATE

Put 100 g chocolate into a small deep glass dish. Heat for 3-5 minutes, using 450 W until chocolate is melted. Stir once or twice during melting. Use oven gloves while taking out!

### MELTING CRYSTALLIZED HONEY

Put 20 g crystallized honey into a small deep glass dish. Heat for 20-30 seconds using 300 W until honey is melted.

### MELTING GELATINE

Lay dry gelatine sheets (10 g) for 5 minutes into cold water. Put drained gelatine into a small glass pyrex bowl. Heat for 1 minute using 300 W. Stir after melting.

### COOKING GLAZE/ICING (FOR CAKE AND GATEAUX)

Mix instant glaze (approximately 14 g) with 40 g sugar and 250 ml cold water. Cook uncovered in a glass pyrex bowl for 3½ to 4½ minutes using 800 W, until glaze/icing is transparent. Stir twice during cooking.

### COOKING JAM

Put 600 g fruits (for example mixed berries) in a suitable sized glass pyrex bowl with lid. Add 300 g preserving sugar and stir well. Cook covered for 10-12 minutes using 800 W. Stir several times during cooking. Empty directly into small jam glasses with twist-off lids. Stand on lid for 5 minutes.

### COOKING PUDDING

Mix pudding powder with sugar and milk (500 ml) by following the manufacturers instructions and stir well. Use a suitable sized glass pyrex bowl with lid. Cook covered for 6½ to 7½ minutes using 800 W. Stir several times well during cooking.

### BROWNING ALMOND SLICES

Spread 30 g sliced almonds evenly on a medium sized ceramic plate. Stir several times during browning for 3½ to 4½ minutes using 600 W. Let it stand for 2-3 minutes in the oven. Use oven gloves while taking out!

## troubleshooting and error code

### TROUBLESHOOTING

If you have any of the problems listed below try the solutions given.

#### This is normal.

- Condensation inside the oven.
- Air flow around the door and outer casing.
- Light reflection around the door and outer casing.
- Steam escaping from around the door or vents.

#### The oven does not start when you press the START/+30s button.

- Is the door completely closed?

#### The food is not cooked at all.

- Have you set the timer correctly and/or pressed the **START/+30s** button?
- Is the door closed?
- Have you overloaded the electric circuit and caused a fuse to blow or a breaker to be triggered?

#### The food is either overcooked or undercooked.

- Was the appropriate cooking length set for the type of food?
- Was an appropriate power level chosen?

#### The light bulb is not working.

- The Light bulb should not be replaced in person for safety reasons. Please contact nearest authorised Samsung customer care, to arrange for a qualified engineer to replace the bulb.

#### The oven causes interference with radios or televisions.

- Slight interference may be observed on televisions or radios when the oven is operating. This is normal. To solve this problem, install the oven away from televisions, radios and aerials.
- If interference is detected by the oven's microprocessor, the display may be reset. To solve this problem, disconnect the power plug and reconnect it. Reset the time.

#### Sparking and cracking occur inside the oven (arcing).

- Have you used a dish with metal trimmings?
- Have you left a fork or other metal utensil inside the oven?
- Is aluminum foil too close to the inside walls?

### Smoke and bad smell when initial operating.

- It's a temporary condition by new component heating. Smoke and smell will disappear completely after 10 minutes operation.  
To remove smell more quickly, please operate microwave oven with putting lemon formation or lemon juice in the cabinet.

☑ If the above guidelines do not enable you to solve the problem, then contact your local SAMSUNG customer service centre.  
Please have the following information read;

- The model and serial numbers, normally printed on the rear of the oven
- Your warranty details
- A clear description of the problem

Then contact your local dealer or SAMSUNG aftersales service.

### ERROR CODE

#### “SE” message indicates.

- Clean the keys and check if there is water on the surface around key. Turn off the microwave oven and try setting again. If it occurs again, call your local SAMSUNG Customer Care Centre.
- ☑ For any codes not listed above, or if the suggested solution does not solve the problem, contact your local SAMSUNG Customer Care Centre.

Подлежит использованию по назначению  
в нормальных условиях  
Срок службы: 7 лет



Символ «не для пищевой продукции» применяется в соответствии с техническим регламентом Таможенного союза «О безопасности упаковки» 005/2011 и указывает на то, что упаковка данного продукта не предназначена для повторного использования и подлежит утилизации. Упаковку данного продукта запрещается использовать для хранения пищевой продукции.



Символ «петля Мебиуса» указывает на возможность утилизации упаковки. Символ может быть дополнен обозначением материала упаковки в виде цифрового и/или буквенного обозначения.

## technical specifications

SAMSUNG strives to improve its products at all times. Both the design specifications and these user instructions are thus subject to change without notice.

Model	MG23H3115**
Power source	230 V ~ 50 Hz
Power consumption	
Microwave	1200 W
Grill	1100 W
Combined mode	2300 W
Output power	100 W / 800 W (IEC-705)
Operating frequency	2450 MHz
Magnetron	OM75P(31)
Cooling method	Cooling fan motor
Dimensions (W x H x D)	
Outside	489 x 275 x 392 mm
Oven cavity	330 x 211 x 324 mm
Volume	23 liter
Weight	
Net	13.5 kg approx

### ЭНЕРГЕТИЧЕСКАЯ ЭФФЕКТИВНОСТЬ

Коэффициент полезного действия, %	55 %
Адрес и наименование лаборатории	Самсунг Электроникс Ко. Лтд. Республика Корея, 416 Маetan-3 Донг, Ёлеонгтонг-Гу, Сувон, Кюнки-До
Характеристики энергетической эффективности определены согласно Приказу Министерства промышленности и торговли РФ от 29 апреля 2010 г. № 357	
На продукте присутствует наклейка с информацией о его энергетической эффективности ※ оборудование класса I	

English - 40

**MEMO**

---

**MEMO**

---

**08 TECHNICAL SPECIFICATIONS**



**Производитель :** Samsung Electronics Co., Ltd /  
Самсунг Электроникс Ко., Лтд

**Адрес производителя :**  
(Мэтан-донг) 129, Самсунг-ро, Йонгтонг-гу, Сувон-си,  
Гйонгги-до, Корея, 443-742

**Адрес мощностей производства :**  
ЛОТ 2, ЛЕБУХ 2, НОРС КЛАНГ СТРЕЙТС, ЭРИА 21,  
ИНДАСТРИАЛ ПАРК, 42000  
ПОРТ КЛАНГ, СЕЛАНГОР ДАРУЛ ЭСАН, МАЛАЙЗИЯ

**Страна производства :** Малайзия

**Импортер в России :**  
ООО «Самсунг Электроникс Рус Компани»  
Адрес: 125009, г. Москва, Россия, ул. Воздвиженка 10, 4 этаж

В СЛУЧАЕ ВОЗНИКНОВЕНИЯ ВОПРОСОВ ИЛИ КОММЕНТАРИЕВ

СТРАНА	ТЕЛЕФОН	ВЕБ-УЗЕЛ
RUSSIA	8-800-555-55-55	www.samsung.com
GEORGIA	0-800-555-555	
ARMENIA	0-800-05-555	
AZERBAIJAN	088-55-55-555	
KAZAKHSTAN	8-10-800-500-55-500(GSM: 7799)	
UZBEKISTAN	8-10-800-500-55-500	
KYRGYZSTAN	00-800-500-55-500	
TADJIKISTAN	8-10-800-500-55-500	
Mongolia	+7-800-555-55-55	
BELARUS	810-800-500-55-500	
MOLDOVA	0-800-614-40	www.samsung.com/ua (Ukrainian) www.samsung.com/ua_ru (Russian)
UKRAINE	0-800-502-000	

DE68-04240C-00