

Q2U RECORDING PAK

USB/XLR MICROPHONE WITH HP20 HEADPHONES



Owners Manual

SAMSON

Table of Contents

Introduction	2
Q2U Features	4
Q2U Layout.	5
Installing the Q2U	6
Getting Started with Windows XP	6
Getting Started with Windows Vista	9
Getting Started with MAC OS X	11
Operating the Q2U.	13 - 19
Q2U Quick Start	13
Powering the Q2U.	15
Setting Up the Signal Level	15
Stand Mounting the Q2U	15
Polar Patterns.	16
Microphone Placement	16
P-Popping.	17
Application Notes	18
Q2U Specifications	20 - 21

Introduction

Congratulations on your purchase of the Q2U Recording Pack from Samson! The package contains all you need to get started recording, and monitoring, high quality audio on just about any computer system with a USB connection. Included in the pack is the Q2U, 2-in-1 USB Microphone with USB cable for recording any sound source and the HP20 stereo headphones, which provide crystal clear monitoring of your recordings. Plus, the Q2U has a standard XLR output allowing you to use the included XLR cable to connect to your sound system for live performances. The Q2U features a smooth sounding dynamic element, capable of handling high SPL (sound pressure level), cleverly interfaced to onboard high quality mic pre, Analog-to-Digital converter and USB output. There's even an onboard headphone amplifier with level control so you can connect the HP20 directly to the microphone. The Q2U is perfect for recording your music, podcast or an acoustic audio source on your favorite DAW (Digital Audio Workstation). Just plug in the supplied USB cable, launch your DAW and start recording. The Q2U faithfully reproduces a variety of sound sources including vocals, acoustic instruments and overhead cymbals, to name a few, and because the Q2U can handle high SPL you can use it on drums or in front of a loud guitar amp. The extended frequency and fast transient response ensures an accurate reproduction with linear characteristics from bottom to top. For recording music, podcasts, house of worship services, or conferences meetings, the Q2U and HP20 are the perfect solution for recording quality digital audio on your computer. Just plug in and start creating!

Introduction

In these pages, you'll find a detailed description of the features of the Q2U 2-in-1 USB Microphone, as well as step-by-step instructions for its setup and use, and full specifications. You'll also find a warranty card enclosed—please don't forget to fill it out and mail it in so that you can receive online technical support and so we can send you updated information about these and other Samson products in the future.

With proper care, your Q2U will operate trouble free for many years. We recommend you record your serial number in the space provided below for future reference.

Serial number: _____

Date of purchase: _____

Should your unit ever require servicing, a Return Authorization number (RA) must be obtained before shipping your unit to Samson. Without this number, the unit will not be accepted. Please call Samson at 1-800-3SAMSON (1-800-372-6766) for a Return Authorization number prior to shipping your unit. Please retain the original packing materials and if possible, return the unit in the original carton and packing materials. If you purchased your Samson product outside the United States, please contact your local distributor for warranty information and service.

Q2U Recording Pack Features

- Dynamic Microphone with USB digital output and standard XLR analog output.
- Full range, linear frequency response for accurate sound reproduction.
- Cardioid, or unidirectional, pick-up pattern for maximum gain before feedback.
- Compatible with most any Mac or PC based Digital Audio Workstation that supports the USB Audio class.
- The onboard headphone amplifier with level control allows you to listen to your recording directly from the microphone, plus you can use the output to connect active studio monitors.
- A software-controlled, analog direct monitor mode is provided for zero-latency monitoring.
- Computer-controlled analog Input Gain makes it easy to set the proper level and get a clean signal.
- The on-board, high quality AD converters with 16-bit, 48 kHz sampling rate provide better than CD quality recording.
- HP20 Headphones included for high quality stereo monitoring.
- On the road, in the studio or in a fixed installation, the solid construction with die cast construction makes the microphone a reliable audio tool, day in and day out.
- A desktop tripod stand, mic clip, 10 foot USB cable and 10 foot XLR cable are included to easily set up the microphone right out of the box.
- The Q2U is perfect for recording voice, music, live instruments, podcasts, or for chatting and VoIP.

Q2U Layout

- 1. Windscreen** – Dual stage grill protects the capsule and helps reduce wind noise and p-popping.
- 2. Capsule** – Internally shock isolated, Dynamic microphone element with Cardioid pick up pattern.
- 3. LED** – The dual color Power/Clip LED lights green to indicate power, and flashes red when the input signal is clipping.
- 4. ON/OFF switch** – Used to turn the microphone's both the USB and XLR outputs on or off.
- 5. Die-cast body** – Super tough molded zinc body construction provides long lasting reliability for recording or live stage use.
- 6. Output Level control** - Up and Down push-button switches used to control the overall volume of the headphone or assigned output device.
- 7. XLR connector** – Standard Male XLR connector with analog output for connecting to a standard PA system.
- 8. USB** – Mini-B size USB connector for interfacing with your PC or Mac.
- 9. Phones** - 1/8-inch (3.5mm) stereo jack for connecting headphones or studio monitors.

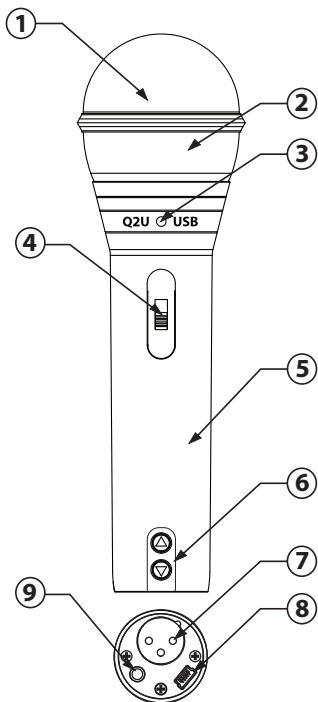

Installing the Q2U

Installing the Q2U is a simple procedure that takes just a few minutes. Since the Q2U is USB compliant, you can use either a MAC or PC, connect the included USB cable and plug and play. You will be able to control your Q2U using the standard audio interface controls in the MAC or Windows operating system. You will find detailed instructions on setting up with MAC OS and Windows in the following sections of this manual.

Getting Started with Windows XP

1. The first time you plug the Q2U into a USB port, Windows will install the universal drivers for that port. A balloon tip will pop up, telling you it has “Found new Hardware” (figure 1).
2. When it is finished installing the drivers, it will say “Your new hardware is installed and ready to use” (figure 2).

Note: This balloon will not pop up again for the same USB port.



Figure 1



Figure 2



Figure 3

Installing the Q2U

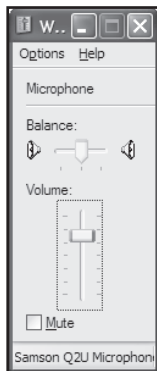

Figure 4

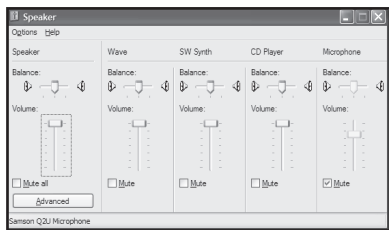

Figure 5

3. To set the Q2U as your default device for sound playback and recording, or to change its settings, click the **Start** button, click **Control Panel** and then click **Sounds and Audio Devices**. Under the **Audio** tab, you can select the Samson Q2U from the drop-down menus. (figure 3).
4. To set the gain of the microphone, click the **Volume** button in the **Sound recording** section to make the **Microphone** slider appear (figure 4). It will say “Samson Q2U” in the status bar at the bottom. Moving this slider will adjust the analog amplifier circuitry in the microphone.
5. To set the direct monitoring level or the playback volume in the headphones, click the **Volume** button in the **Sound playback** section instead. Adjusting either the **Speaker** slider on the left or pushing the push-buttons on the mic changes the headphone level (figure 5). To turn off the zero-latency direct hardware monitoring (if you want to use software play-through with effects instead), click

Installing the Q2U

the **Mute** checkbox in the **Microphone** section on the right. If the Microphone section does not appear at first, click **Options** and then **Properties** (figure 6), and click the checkbox next to **Microphone**. (Figure 7)

6. To prevent system sounds from coming through the Q2U, select a different sound card for the system default, and then choose the Q2U manually within your DAW software.

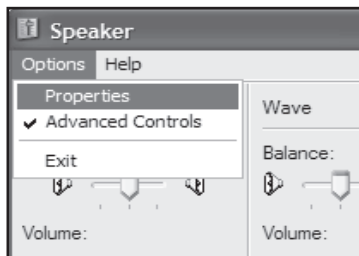

Figure 6

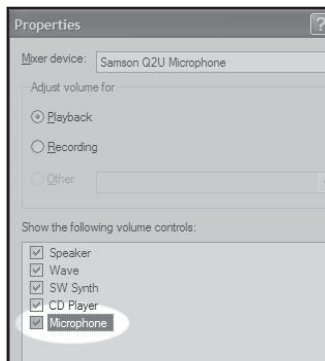

Figure 7

Installing the Q2U

Getting Started with Windows Vista

1. The first time you plug the Q2U into a USB port, Windows Vista will install the universal drivers for that port. A balloon tip will pop up, telling you it has “Found new Hardware”.
2. When it is finished installing the drivers, it will say “Your new hardware is installed and ready to use”.

Note: This balloon will not pop up again for the same USB port.

3. To set the Q2U as your default device for sound playback and recording, or to change its settings, click the **Start** button, click **Control Panel** and then click **Sound**. Under the **Playback** and **Recording** tabs, you can select the Samson Q2U from the menus and use the **Set Default** button to set it as the default device. (figure 8).
4. To set the gain of the microphone, make sure the Samson Q2U is selected in the **Recording** tab and click the **Properties** button. Under the **Levels** tab, move the **Microphone** slider to adjust the analog amplifier circuitry in the microphone (figure 9).



Figure 8



Figure 9

Installing the Q2U

5. To set the direct monitoring level or the playback volume in the headphones, click the **Properties** button in the **Playback** tab instead, and open the **Levels** tab. Adjusting the **Speakers** slider or pressing the pushbuttons on the mic changes the headphone level. To turn off the zero-latency hardware direct monitoring (if you want to use software play-through with effects instead), click the **Mute** button (speaker symbol) in the right of the **Microphone** section (figure 11).



Figure 10

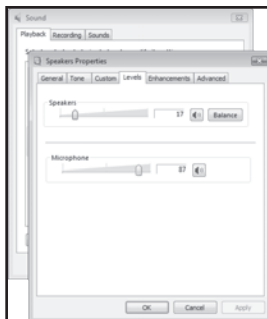

Figure 11

Installing the Q2U

Getting Started with MAC OS X

The following example is for setting up the Q2U in MAC OS X.

1. To start using the Samson Q2U, just plug it in. The LED will light to indicate it is receiving USB power. The MAC will recognize the USB audio device and automatically install a universal driver.
2. To select the Q2U as the computer's default device, open the **System Preferences** from the dock or the main **Apple Menu** (figure 12).

Plug and Play - Some MAC OS DAW's, like Apple's Garage band, will let you plug and play without going to the Sound preference set up. When you plug the Q2U into the USB port you'll see a dialog box that will ask you if you want to select the Q2U. Select yes and you're ready to go.

3. Next open the **Sound** preference (figure 13).
4. Now, click in the **Input** tab and select Q2U (figure 14).
5. To set the gain of the microphone, adjust the Input volume slider at the bottom of the Sound dialog box.
6. Next, click in the **Output** tab and select Q2U.

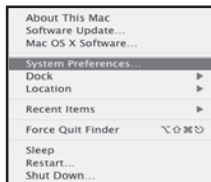

Figure 12



Figure 13



Figure 14

Installing the Q2U

7. To set the playback volume in the headphones, adjust the **Output** volume slider at the bottom of the **Sound** dialog box (figure 15) or press the pushbuttons on the mic.

At this point you can begin using your microphone with most any audio recording software, but you need to select it as an input and output device within the DAW. When selecting the inputs and outputs just look for and select the Q2U.

When recording in your DAW with software monitoring turned on, you may experience a delay on the signal playback, commonly known as latency. The amount of latency depends on the speed of your computer, available memory and the number of tracks you are recording. You can set the Q2U to Direct Monitor mode to listen to the signal directly off the input of the microphone to eliminate the latency.

Using the Direct Monitor

1. To turn direct monitoring on or off, open the **Audio/MIDI Setup** (figure 16) utility located in the **Utility** folder inside the Applications folder.
2. Now click the checkbox in the **Thru** column in **Audio/MIDI Setup**.



Figure 15



Figure 16

Operating the Q2U

Q2U Quick Start

You will find a detailed description of the Q2U's controls and functions in the following sections of this manual. However, if you can't wait to get started, you can follow this quick start guide. Before you get going it's recommended that you follow the instructions on installing the Q2U with either Windows or OS Mac in the previous sections of this manual. Once you confirm the Q2U is connected to your computer properly, it will be easy to start recording. The more you learn about the Q2U, the more you'll discover its versatility and powerful features.

There are many ways to use the microphone, and our quick start example is for a typical set-up for recording vocals.

Just follow the simple steps below to start recording.

1. Unpack the Q2U, and position the microphone on your desktop desk stand.
2. Set the Q2U's ON/OFF switch to the "ON" position and point the end of the microphone towards the vocalist.
3. Next, connect your headphones to the PHONES output located on the bottom side of the Q2U.

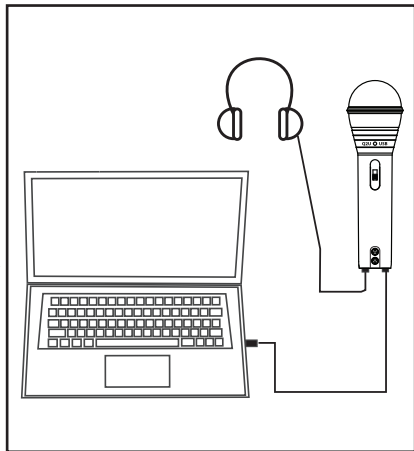

Operating the Q2U

Q2U Quick Start - continued

4. Plug the mini-B size (small) end of the included USB cable into the USB socket also located on the bottom side of the Q2U.
5. Now, plug the other end of the USB cable into an available USB port on your computer.
Note: Be sure to check the installation guide for Windows and Mac OS to confirm your computer has recognized the Q2U. Also, make sure your computer's output level is set to maximum for full volume in the Q2U headphone monitor.
6. Next, launch your DAW, turn down the main output level and select the Q2U for the input and outputs.
7. Set up a mono record track in your DAW for the vocal track.
8. At this point you want to set the level of the Q2U and there are few ways to do this depending on your exact computer set up. You can set the microphone's input level in the Sound playback in Windows or in the Sound dialog box in the System Preferences if you are using the MAC OS.
9. Set level of the microphone by raising the Input level control in your DAW or system to about half way up. If you see the Power/Peak LED light red, your signal will be distorted. Turn the MIC level control down until it does not flash red.
10. Next, put on your HP20 headphones, speak or sing into the mic and then raise the DAW's output level control until you reach a comfortable listening level.

Now, follow the instructions of your DAW software to enable the track for recording and you're ready to record.

Using The XLR Output

You can connect the Q2U to a standard PA mixer for live sound applications using the XLR output. Most PA mixers feature microphone inputs on XLR, so just connect the included XLR cable to your mixer, set the ON/OFF switch to "ON" and follow the mixer manufacturer's instructions for setting the mic level.

Operating the Q2U

Using the Level Controls

The Q2U employs Up and Down Level controls, which are normally used to control the level of the internal headphone amp, however the Level controls will adjust the volume of whichever device (Q2U or internal sound card) is set up as the output. If you set the Q2U as the output device, the Level controls will adjust the headphone output. If you select any of the computer's internal soundcards as the output device, the Level controls will adjust the output volume of the computer via that device. Now, use the Up and Down switches to raise or lower the volume respectively.

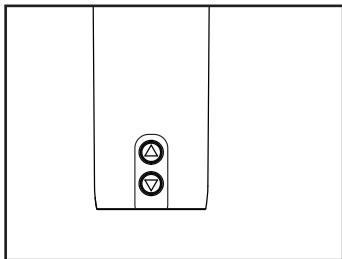

Setting Up the Signal Level

You can adjust the Q2U's internal analog input gain stage by using your software DAW or operating system. The purpose of the level, or gain controls are to optimize the amount of good signal relative to any associated noise. A good mic or instrument pre-amplifier, like the one inside Q2U, will also have a PEAK indicator to show when the input signal is clipping. To set a good level on the mic, set the Q2U up in front of the desired sound source and slowly raise the DAW's or operating system's input gain control until you see the CLIP or Peak indicator light up. Then, turn the input trim control down until the indicator does not light any more. Once you set the input level control you shouldn't need to change them during recording. Use the level controls on the DAW to set the balance between the mic and stereo mix during playback.

Operating the Q2U

Stand Mounting the Q2U

The Q2U can be mounted to a standard microphone stand like the Samson BT4, BL3 or MB1 using the included mic clip. If you are using a U.S. 5/8" mic stand, you will need to unscrew and remove the included Euro stand adapter. Simply screw the Q2U mic clip on to your mic stand or boom arm and adjust the microphone to the desired angle.

Polar Patterns

The most important characteristic of any microphone is its directionality or "pick-up pattern". There are three basic categories of pick up patterns; omni, bidirectional (or figure 8) and cardioid (or unidirectional). Omni mics pick up sound from all directions, bidirectional mics pick up the sound directly in front and back of the microphone while rejecting the sound on the left and right sides, and cardioid mics pick up the sound in front of the microphone. While omni and bidirectional microphones are very useful for a variety of applications, cardioid is desired for a majority of "miking" situations. The cardioid pick up pattern allows for better separation of instruments in the studio and more control over feedback in live sound reinforcement. When positioned correctly, the cardioid pick-up pattern allows you to pick up more of the sound you want and less of the sound you don't want.

Microphone Placement

In order to maximize the sound quality, you must pay careful attention to the placement of your Q2U and how it is positioned for the instrument or vocalist that you are miking. All microphones, especially cardioid microphones, exhibit a phenomenon known as "proximity effect." Very simply put, proximity effect is a resulting change in the frequency response of a microphone based on the position of the mic capsule relative to the sound source. In general, as the microphone moves closer to the sound source, the bass response increases. You can also make subtle changes to the frequency response by making minor adjustment to the position. Specifically, when you point a cardioid mic directly at the sound source (on axis) you will get the best frequency

Operating the Q2U

response, however when you start pointing the microphone slightly away (off axis) you will notice the high frequency response dropping off and the microphone will start to sound like it has more bass and less highs.

For most vocal applications you'll want to position the microphone directly in front of the artist about 4 to 18 inches. If you are close miking a vocal, set the microphone to a slight angle to reduce p-popping. The same may be true for miking instruments, however, you can make some pretty amazing equalization adjustments by slightly changing the angle of the capsule to the sound source. This can be a very useful technique in capturing the optimum sound of drum set, acoustic guitar, piano or other instruments in a live room or sound stage. Experimentation and experience are the best teachers in getting good sounds, so plug in!

P-Popping

P-popping is that annoying pop that you can get when the microphone diaphragm gets a blast of air from a vocalist pronouncing words with the letter "P" included. There are a few ways to deal with the problem including using an external pop filter. Some famous engineers have relied on an old nylon stocking over a bent clothes hanger, which actually works very well. As mentioned above, you can also try placing the microphone slightly off axis (on a slight angle) from the vocalist. This can often solve the problem without using an external pop filter. However, the simplest, most reliable way to reduce P-popping (without the bad smell of old nylons) is to use a pop filter attached the microphone stand like the Samson PS-01. Using a pop filter also makes it easy to maintain a good level by keeping the vocalist at a constant distance from the microphone.

Application Notes

The Q2U is a great microphone choice for many instrument miking situations. Below is a brief guide on using the Q2U in some typical applications:

Vocals

Position the microphone directly in front of the artist so that the microphone grill is approximately 4 to 18 inches away. When close miking vocals, use of an external pop filter like the Samson PS01 is strongly recommended. You can use the Cardioid pattern to record a group of vocalists by positioning them around the front of the microphone. Just remember that the extreme sides of the microphone pick up less with less high frequency response, so have them stand together tight, and/or move the microphone from one to two feet away from the group to pick up more room sound.

Acoustic Guitar

There are a variety of ways that the Q2U can be used to mic an acoustic guitar. The microphone placement will depend on the type of instrument and what kind of sound you're looking to capture. For example, the tonal quality you want to focus on, and how much finger slide or pick noise you may or may not want. When miking a standard steel string acoustic, a good place to start is with the microphone positioned and pointing towards the end of the fingerboard at a distance of about 6 inches to 2 feet away from the instrument. You can experiment by moving the microphone slightly in the direction of the sound hole, which will produce more low frequencies, or move it in the direction of the fingerboard to capture more high-end or to remove any unwanted boominess. For nylon string acoustic, try positioning the microphone above the bridge to emphasize more of the attack from the sound of the finger picking, or for less, move the mic closer to the sound hole. If you have a pair of Q2Us, try one positioned at the fingerboard and the second over the sound hole.

Application Notes

Piano

You can achieve outstanding results using the Q2U on acoustic piano. Several placement approaches can be used depending on the size of the piano, and the type of sound you are looking to record. When miking a Grand Piano, (for an ambient sound like that used in a classical recital), a Q2U can be positioned directly in front of the instrument. Open the lid to the full position and place the microphone five to twenty feet in front of the instrument. For a more contemporary ensemble sound, place two Q2Us in the piano, positioning one over the low strings and the other over the high strings.

Overhead Drum Kit

Because of its extended high frequency response and fast transient response, the Q2U performs outstandingly when used as an overhead cymbal microphone. You can position one Q2U on a boom mic stand directly above the kit pointing from front to back. For stereo miking, use two Q2U's placed over the drum set at a distance of three to five feet. You can experiment with the exact placement depending on the size of the room and whether you're looking for an ambient or close-miked sound. In general, when miking a drum kit, it's a good idea to start with the overhead mics. Even though you use the overhead mics mostly for the cymbals, you can get the entire kit to sound great with just one overhead. Then it will be easier to just bring up your individual mics for more attack and thickness in the overall sound.

Q2U Specifications

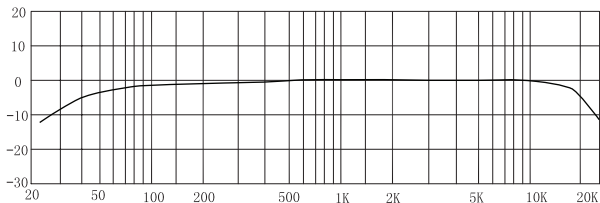

Q2U Frequency Response - Cardioid

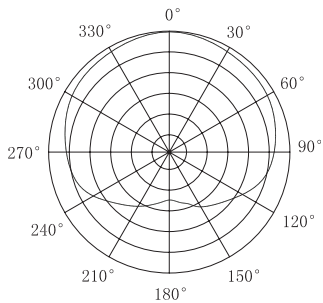

Polar Pattern - Cardioid

Q2U Specifications

Q2U Specifications

Polar pattern	Cardioid
Frequency Response	50Hz - 15 kHz
Element type	Dynamic
Sensitivity	-54 dBV/Pa
SPL	148 dB
Weight	11.2 oz (317.5 g)
Dimensions	7.5 "x 2.2 " (diameter) 190 mm x 55 mm (diameter)

HP20 Headphone Specifications

Driver diameter:	40mm
Frequency range:	20~20000Hz
Sensitivity:	110dB /1mW
Impedance:	32 Ohm
Cable length	2m
Maximum power input	100mW
Connector	3.5 mm Stereo

Specifications subject to change without notice.